

**Courbes Série CC Mag-M
2 x 1^{1/2} x 8 - 1750 tr/mn**

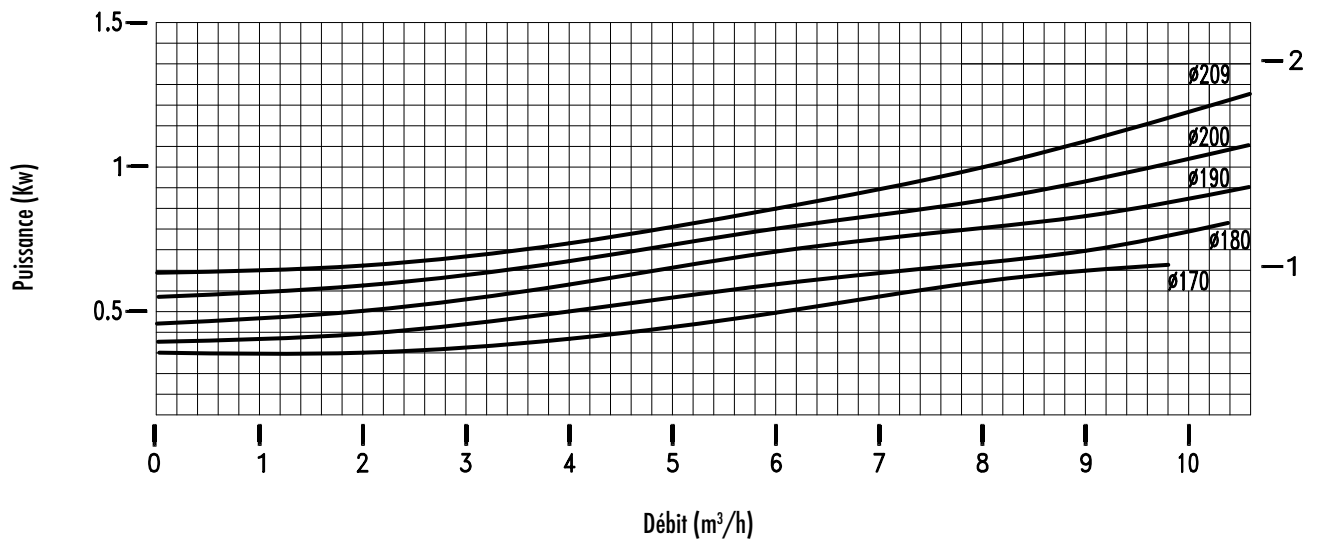

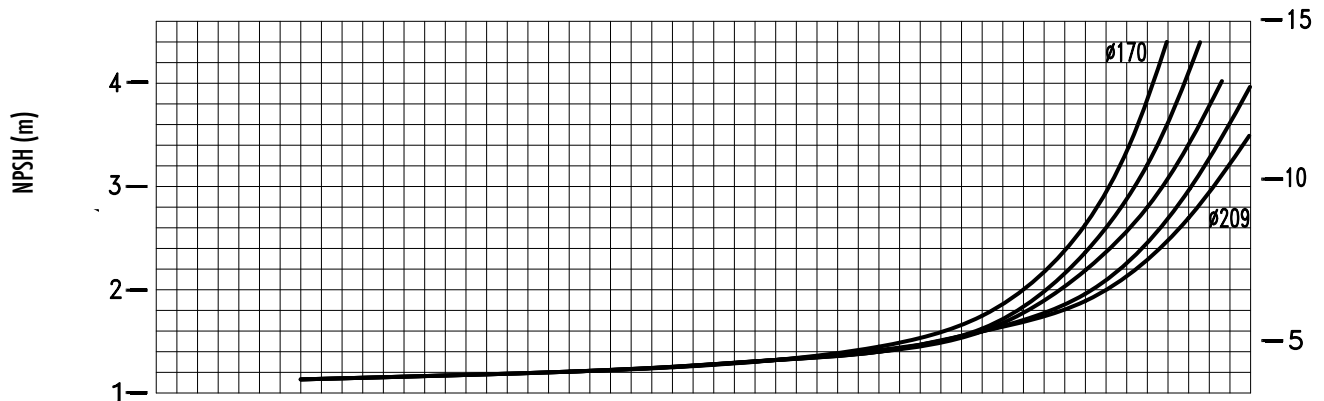

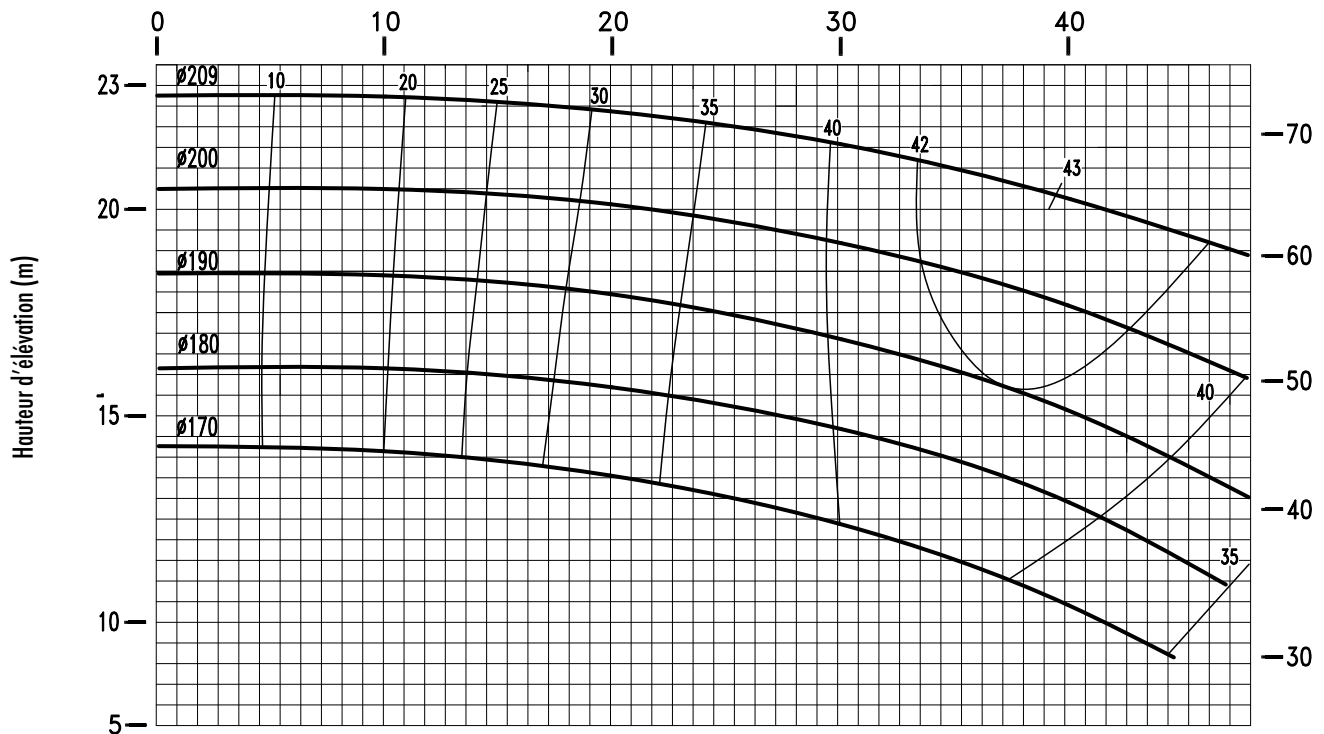
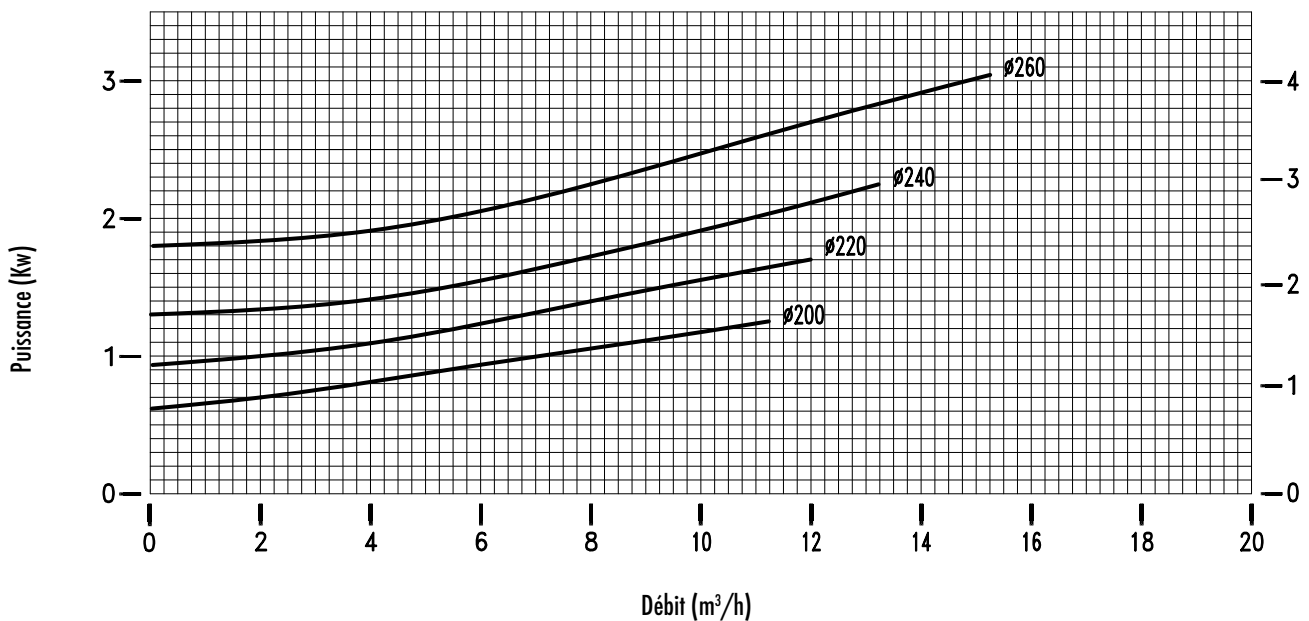
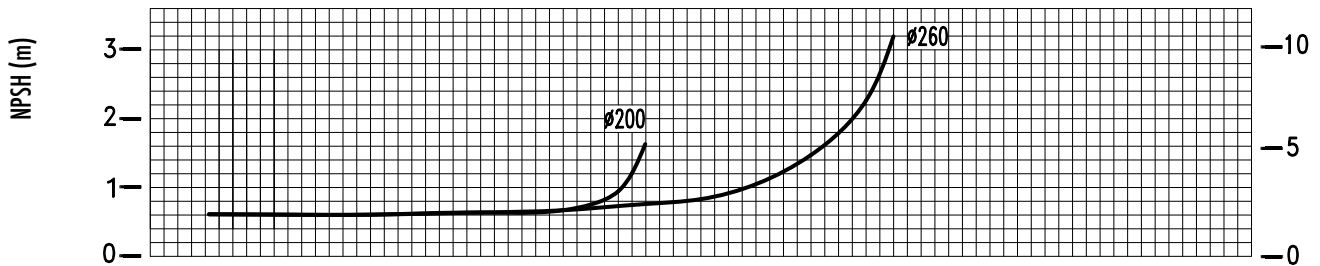
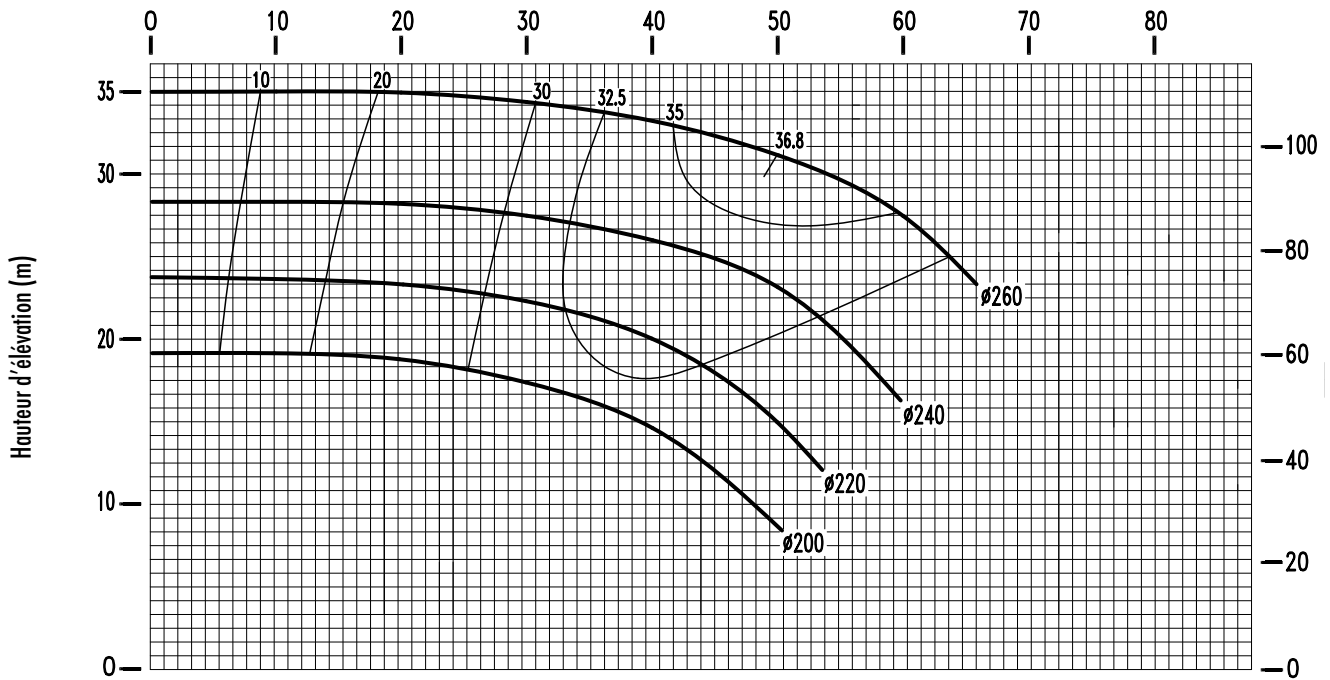

Pompes à entraînement magnétique centrifuges

Courbes Série CC Mag-M 3 x 1^{1/2} x 5 - 1750 tr/mn

Projet :

Poste :

Cotation :

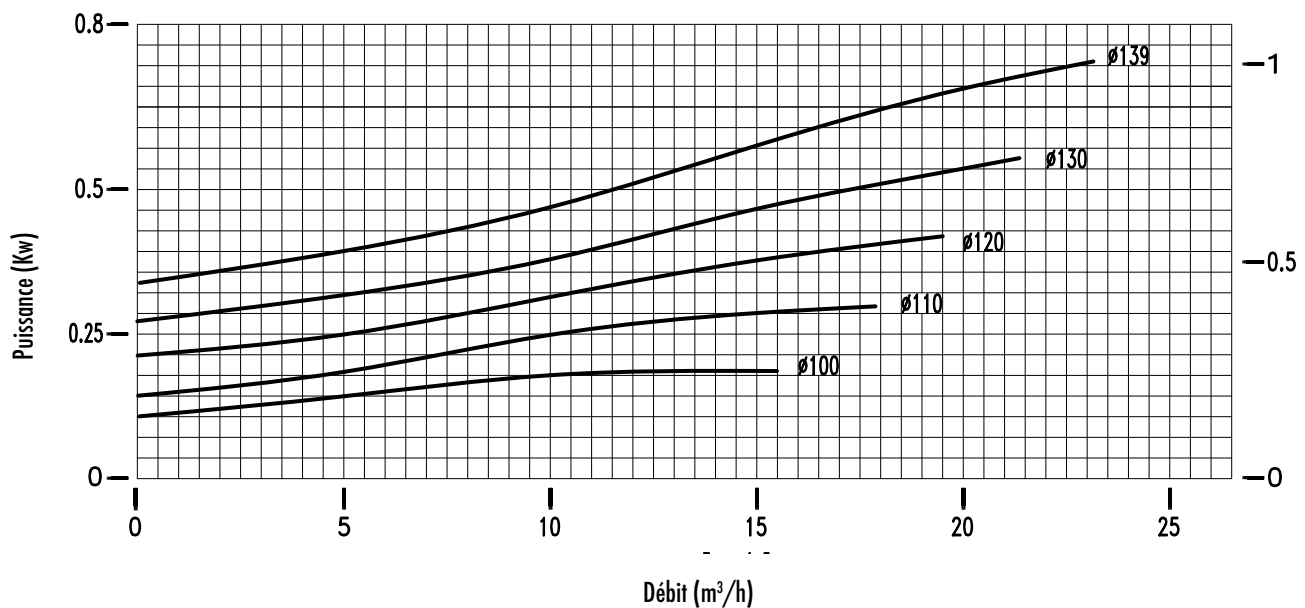
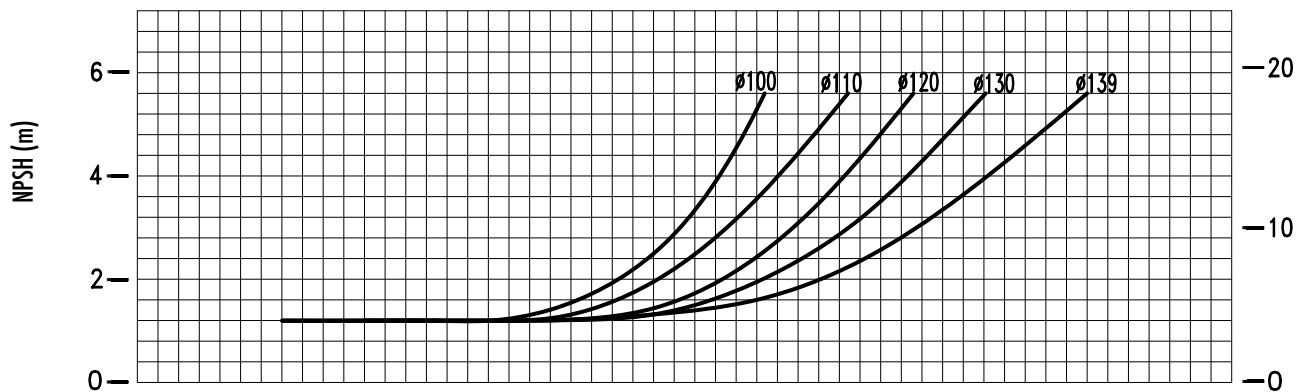
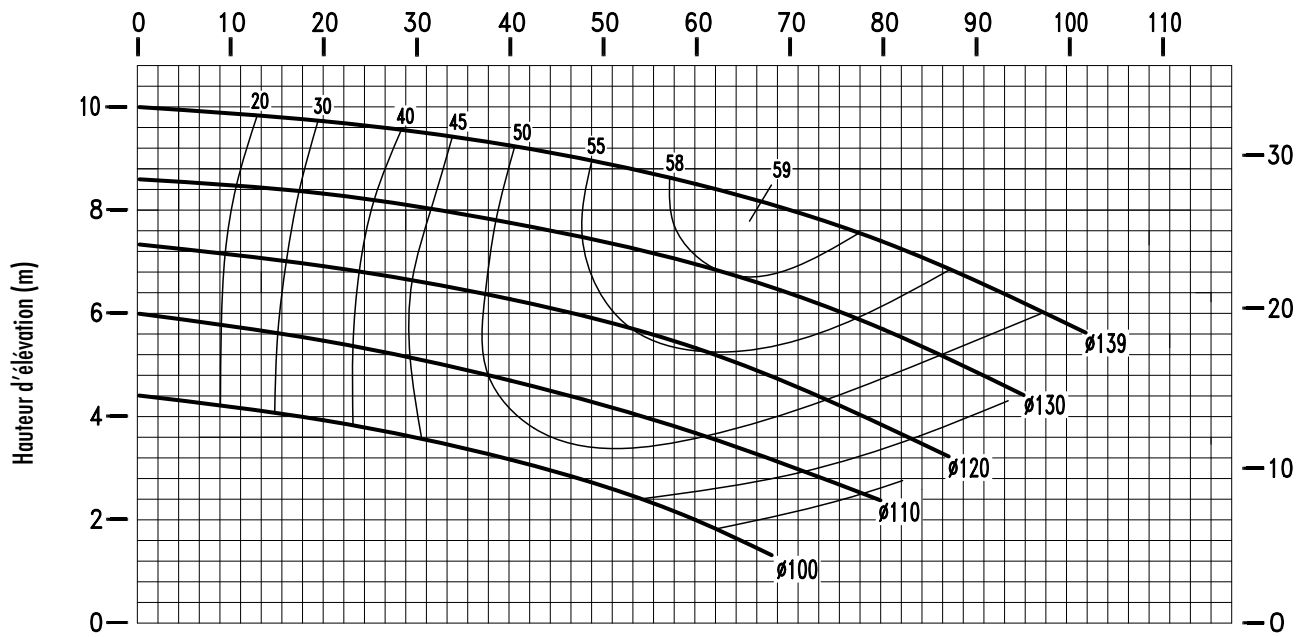

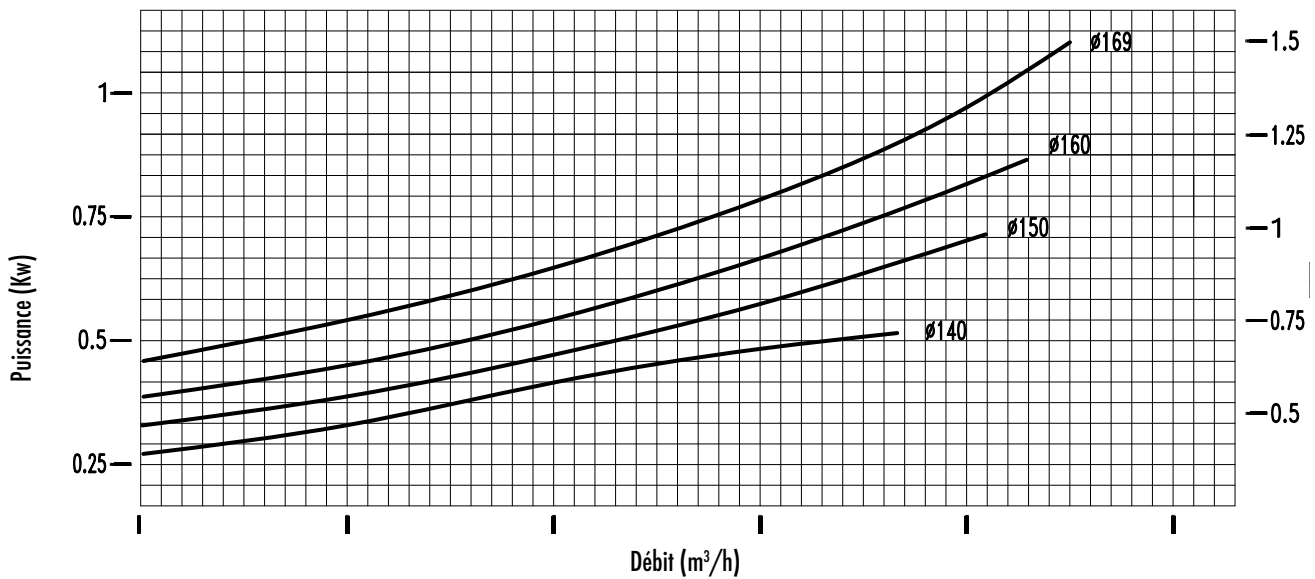
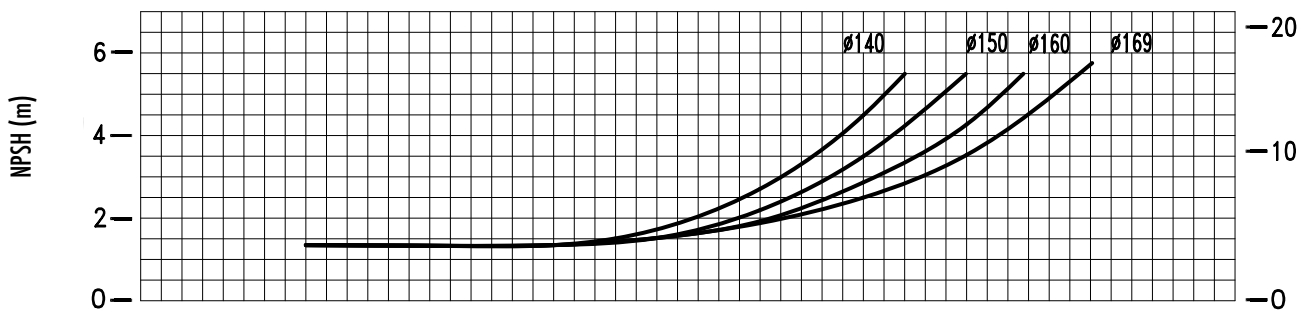
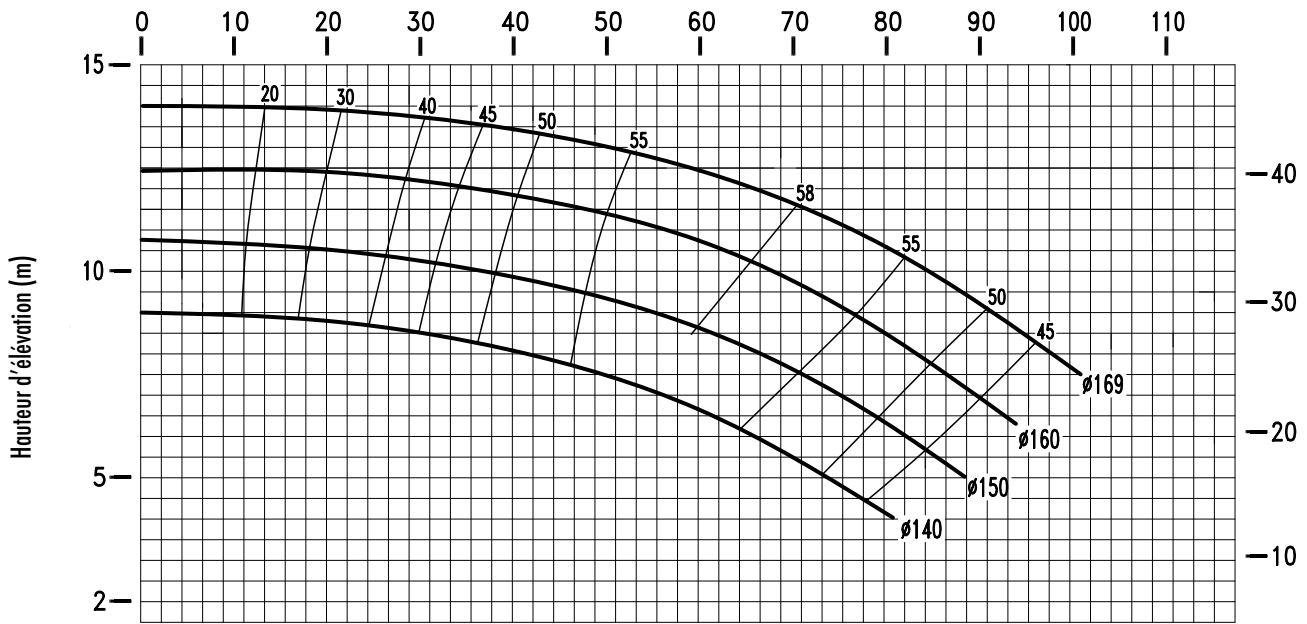

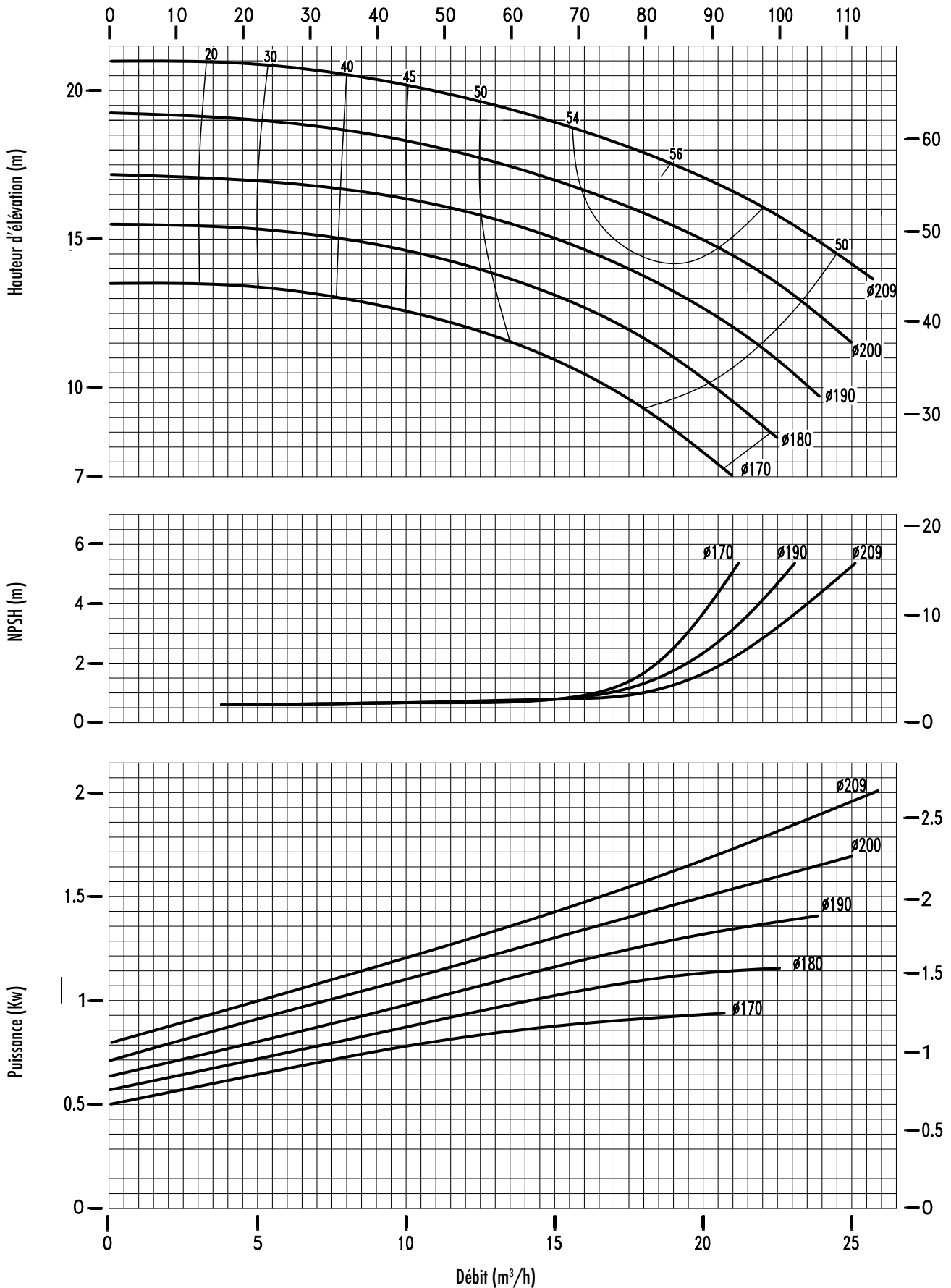

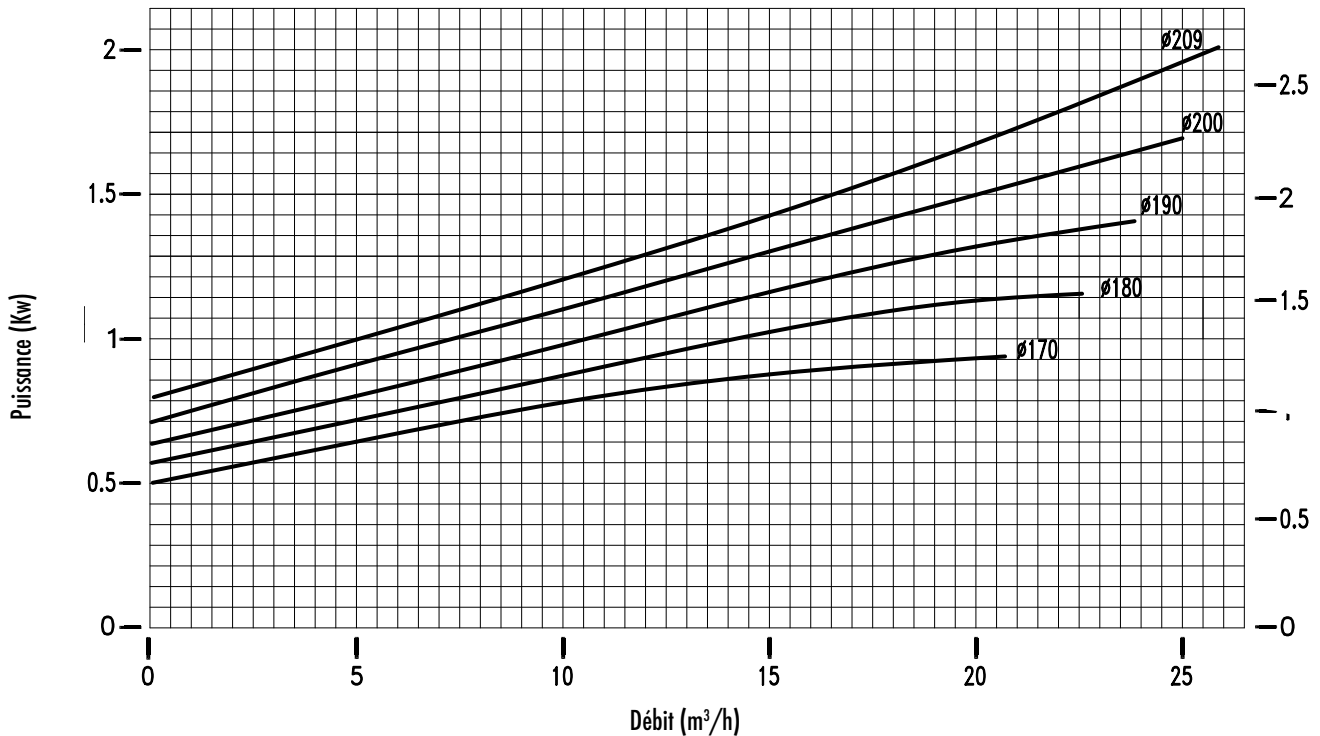
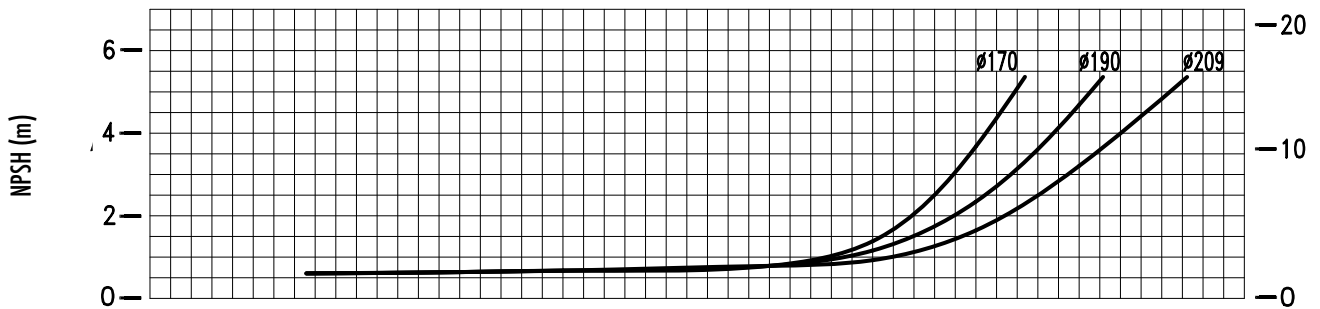
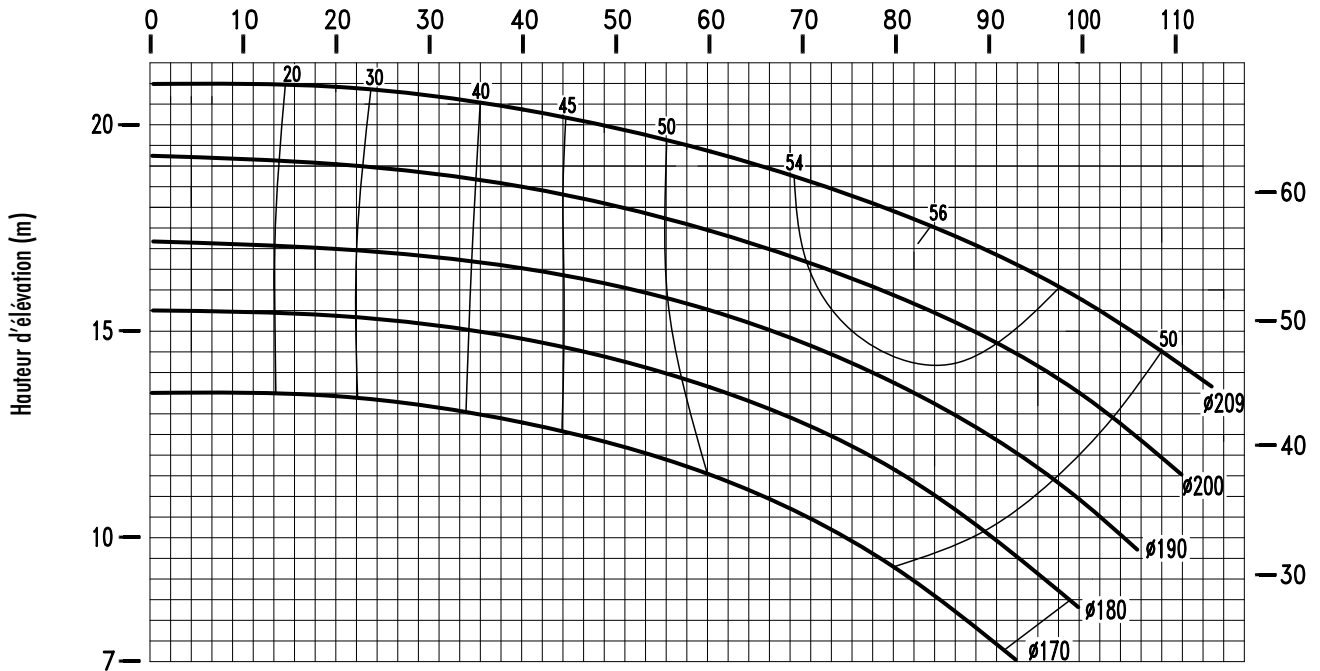

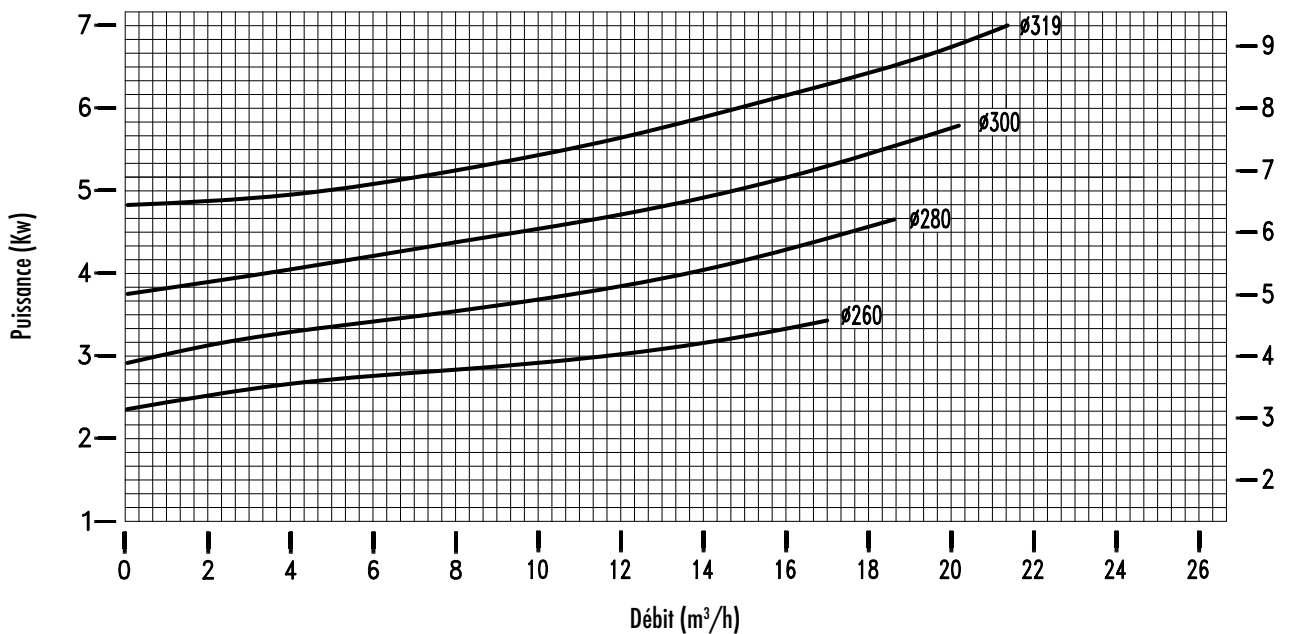
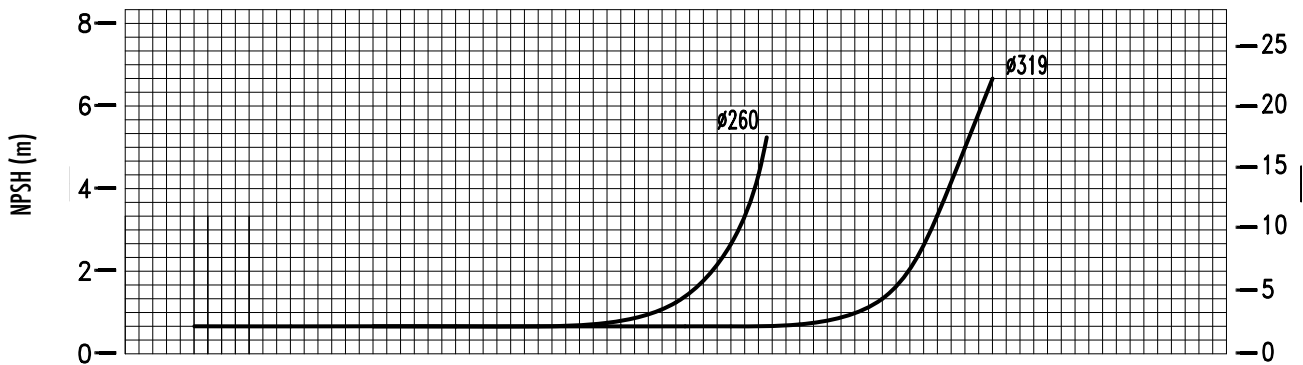
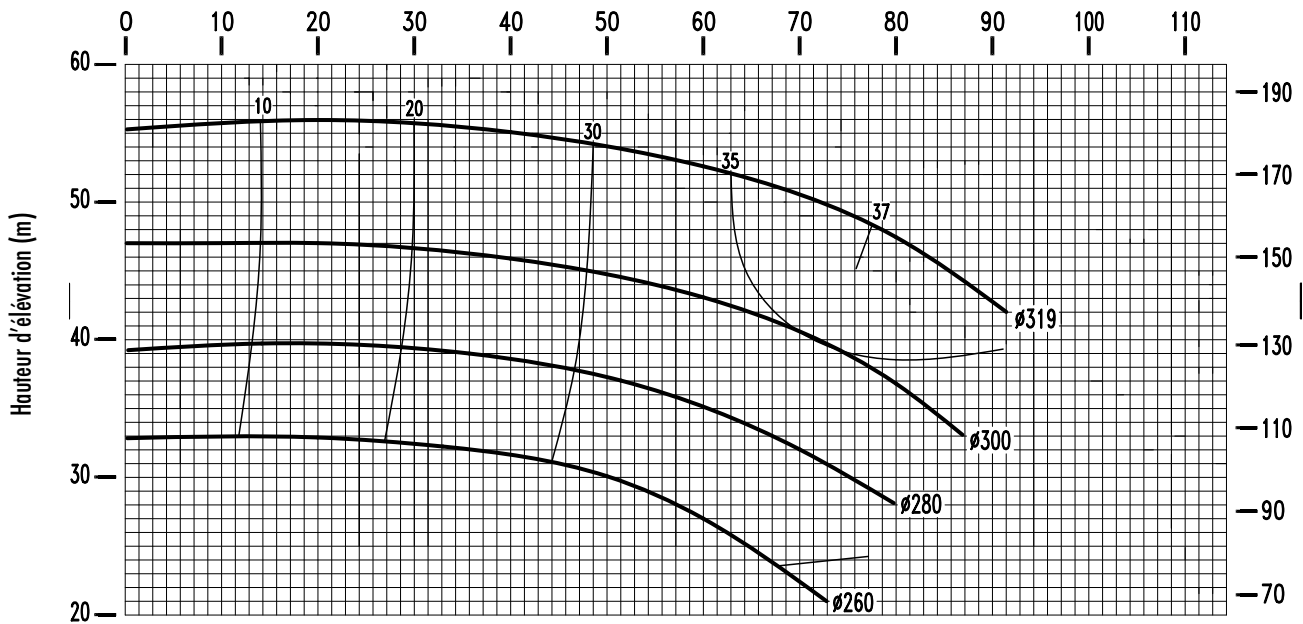

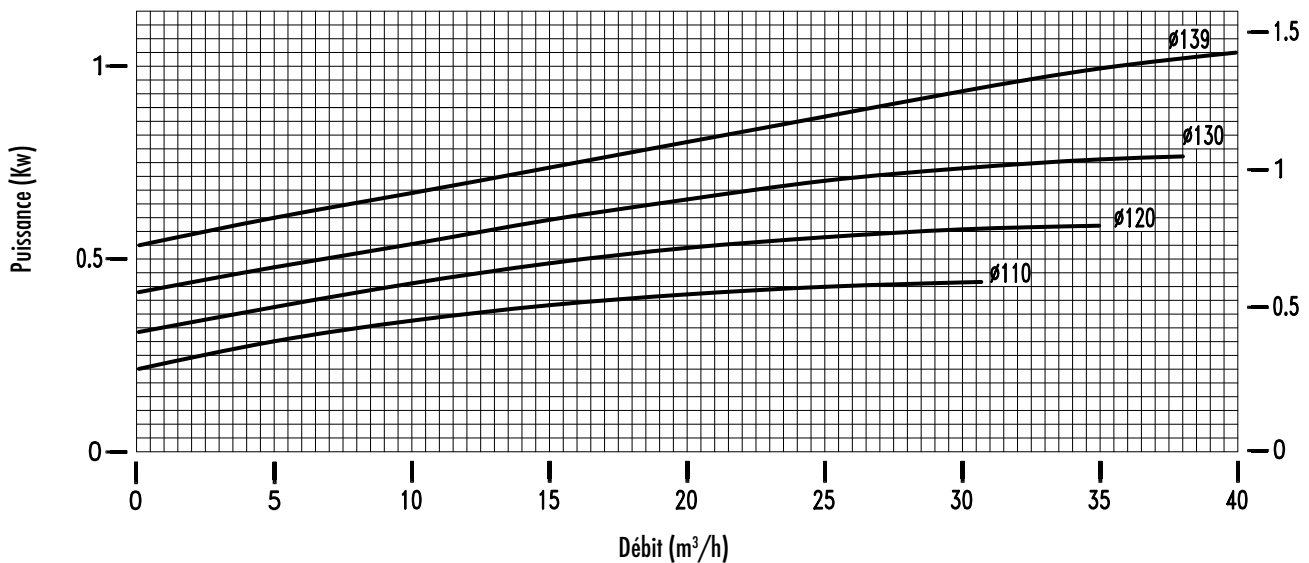
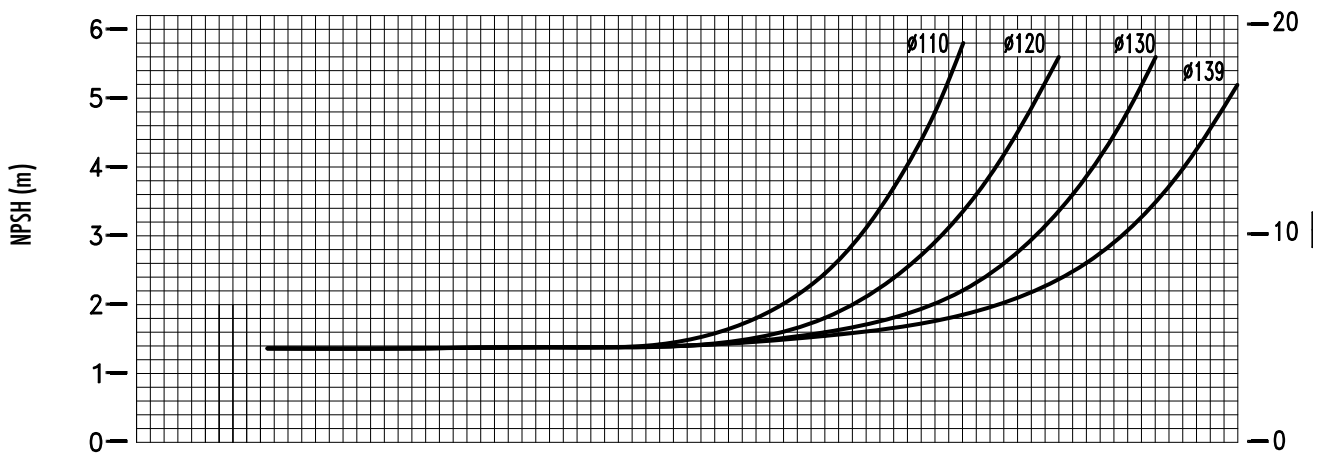
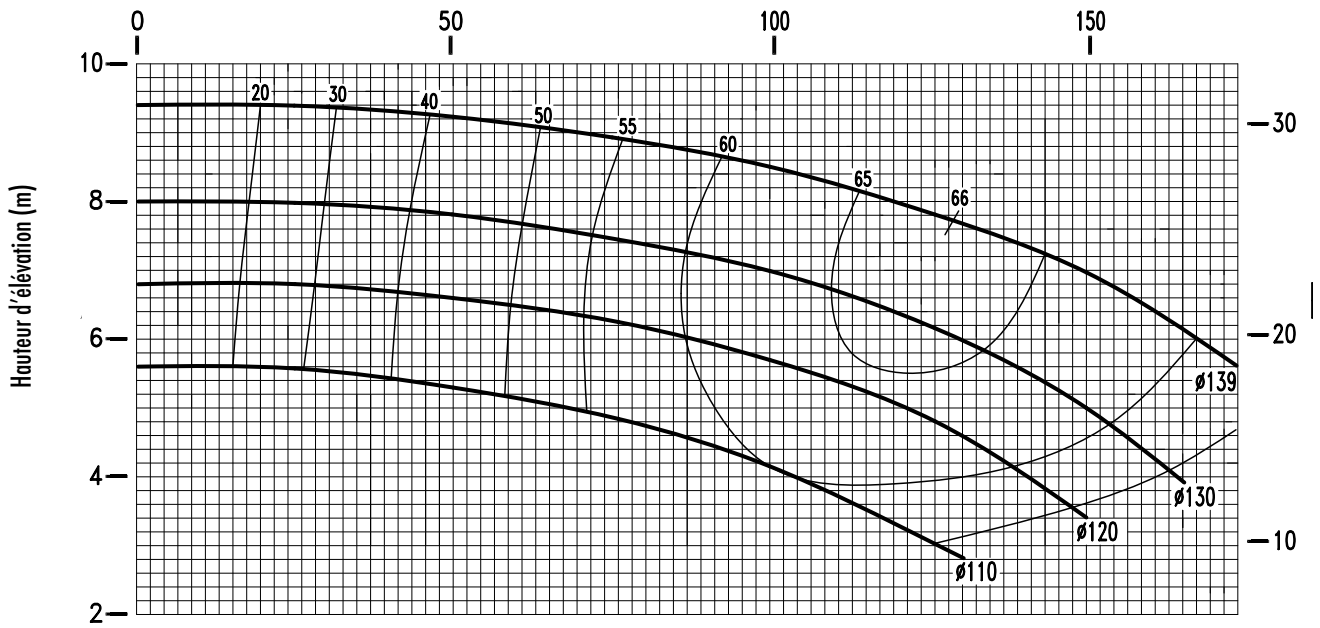

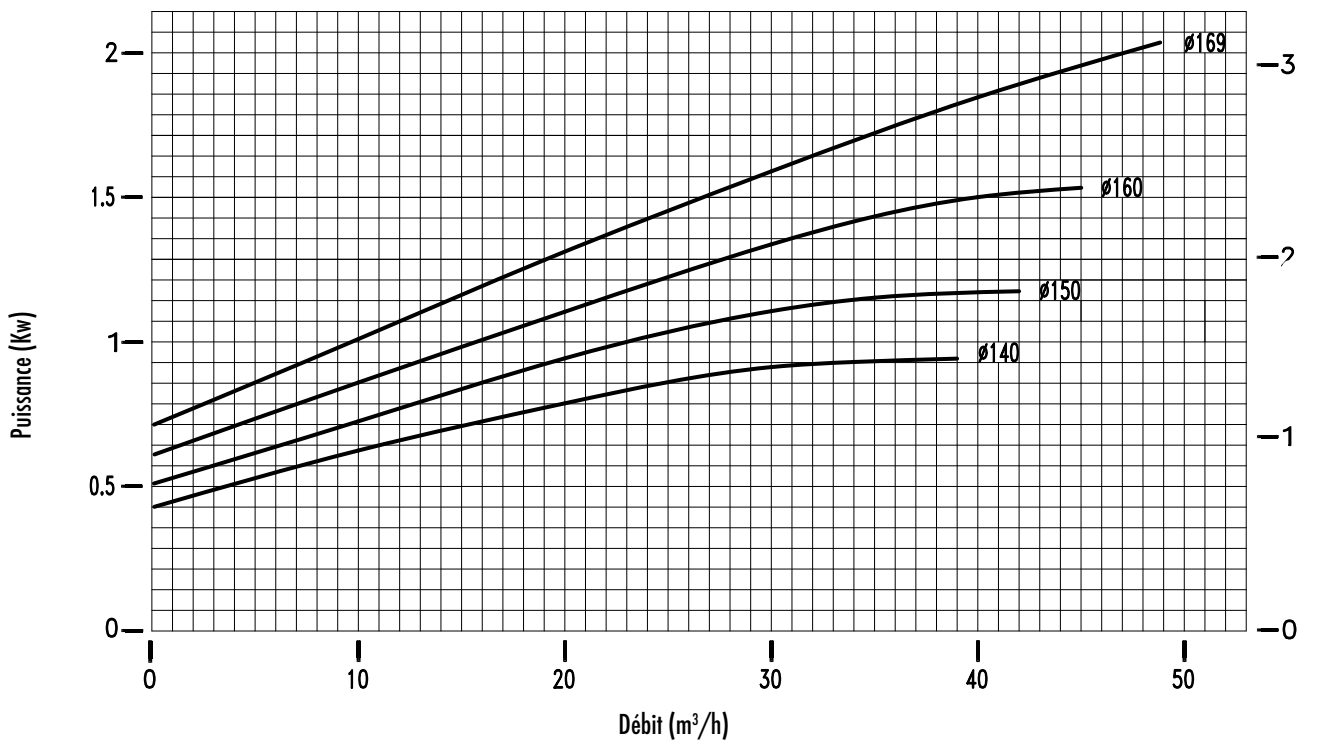
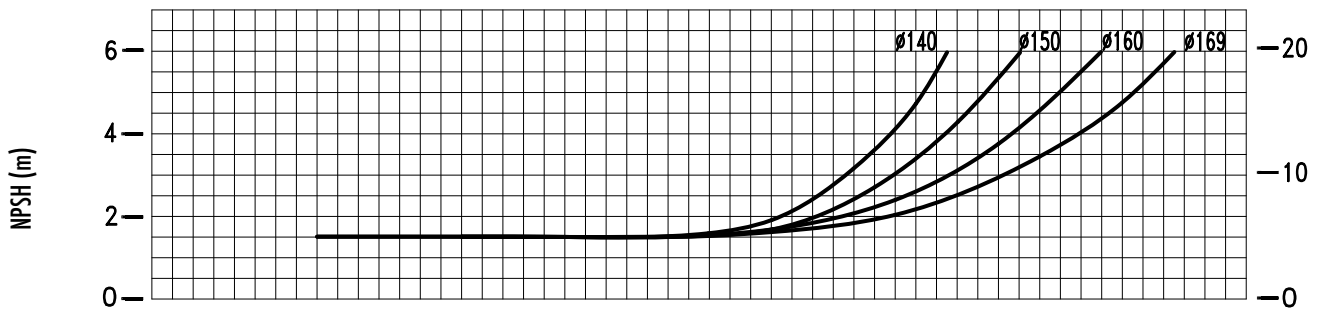
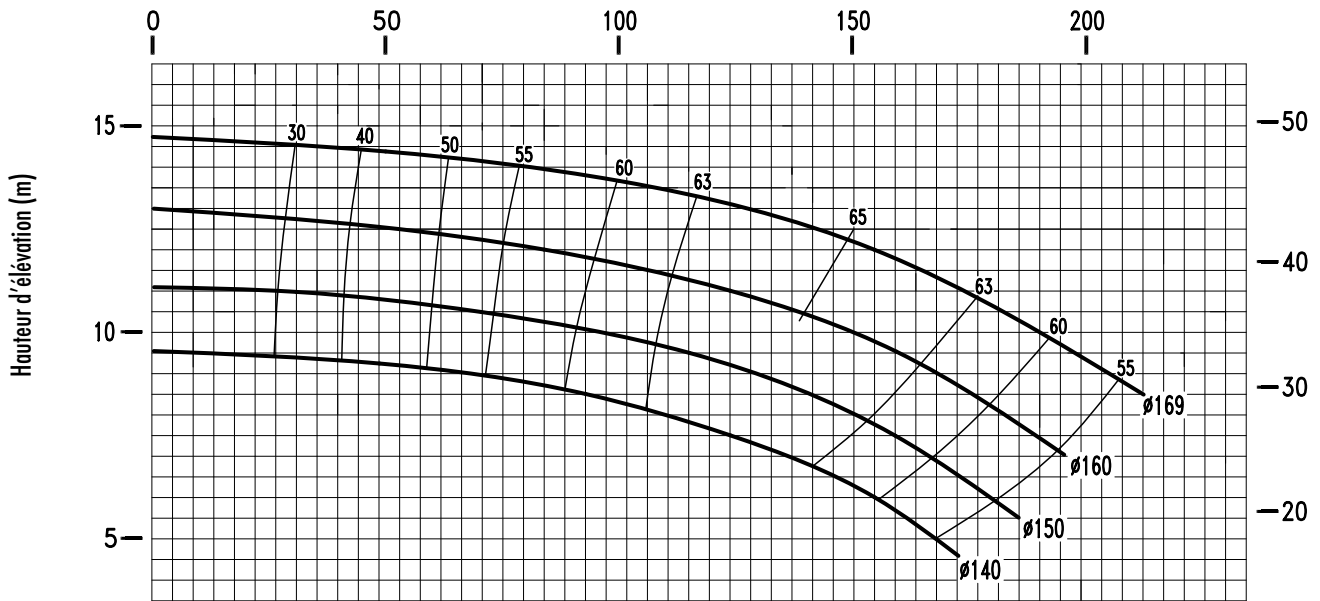

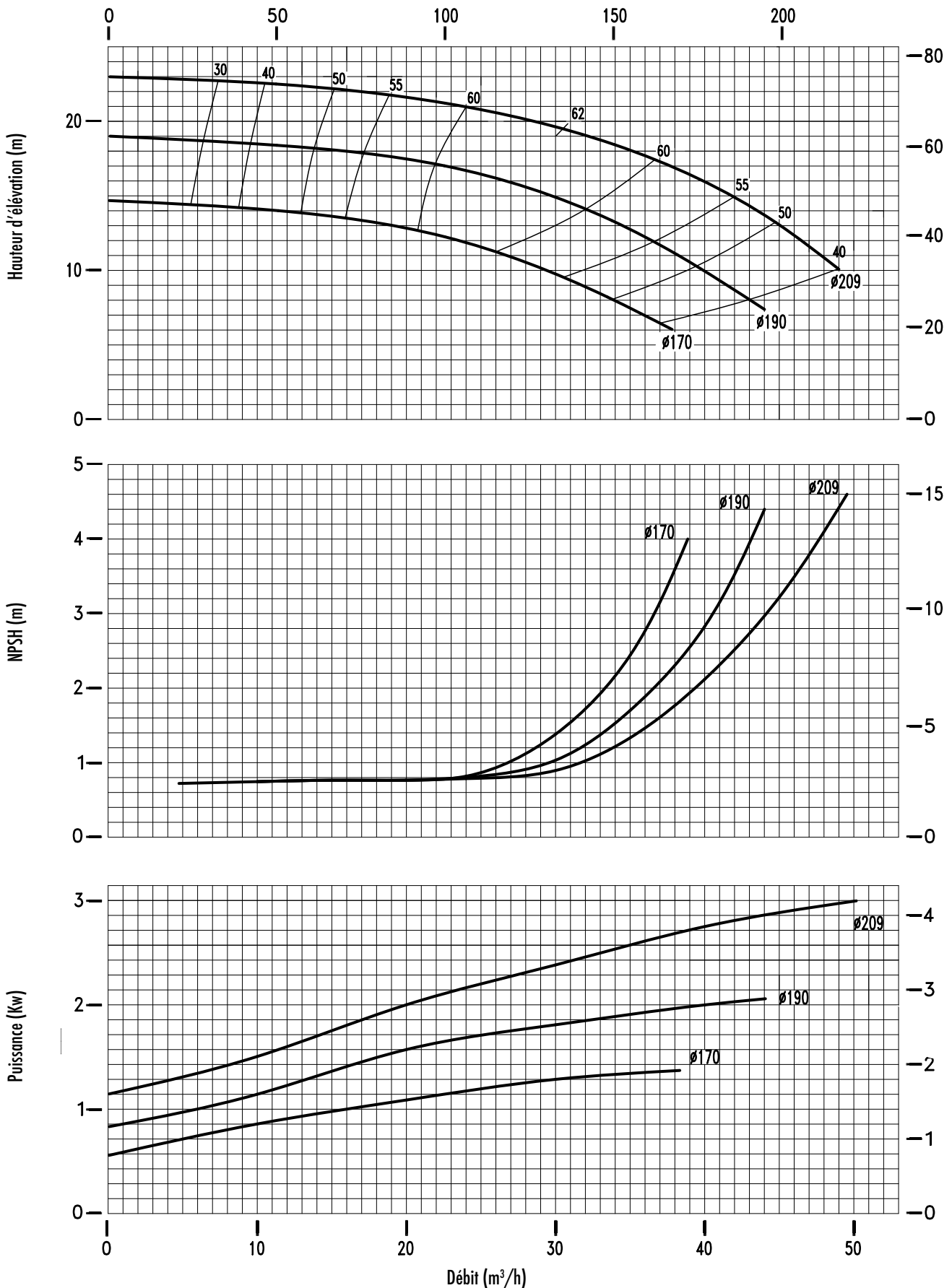

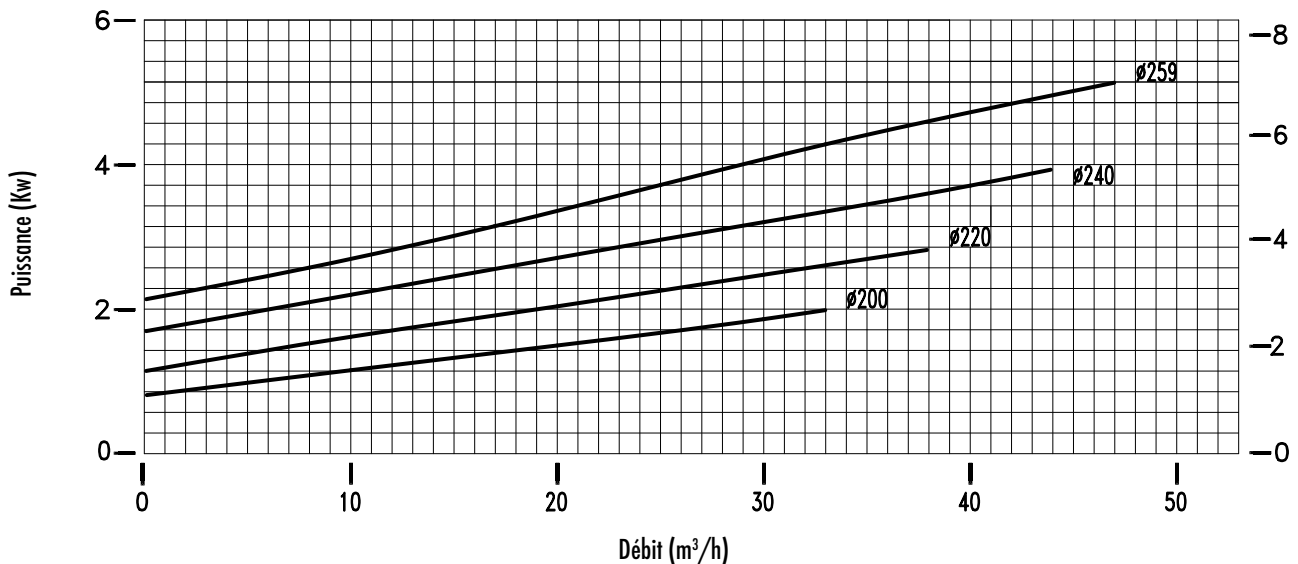
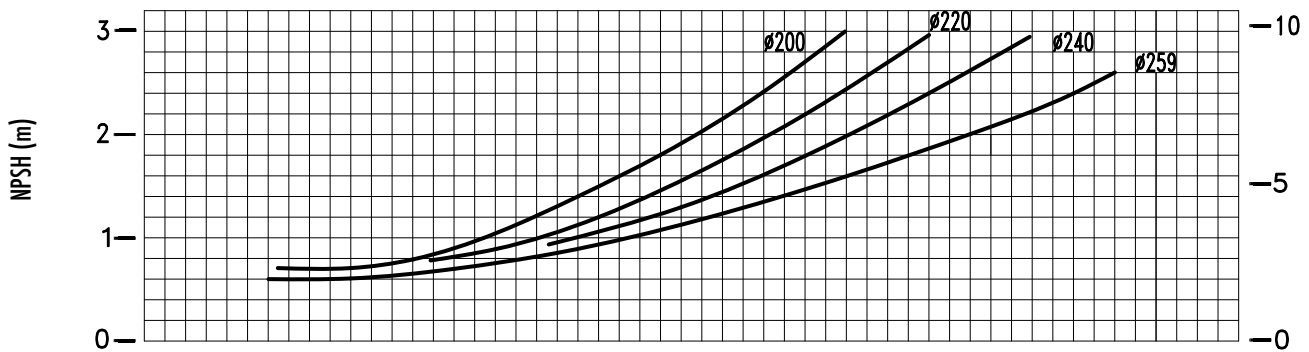
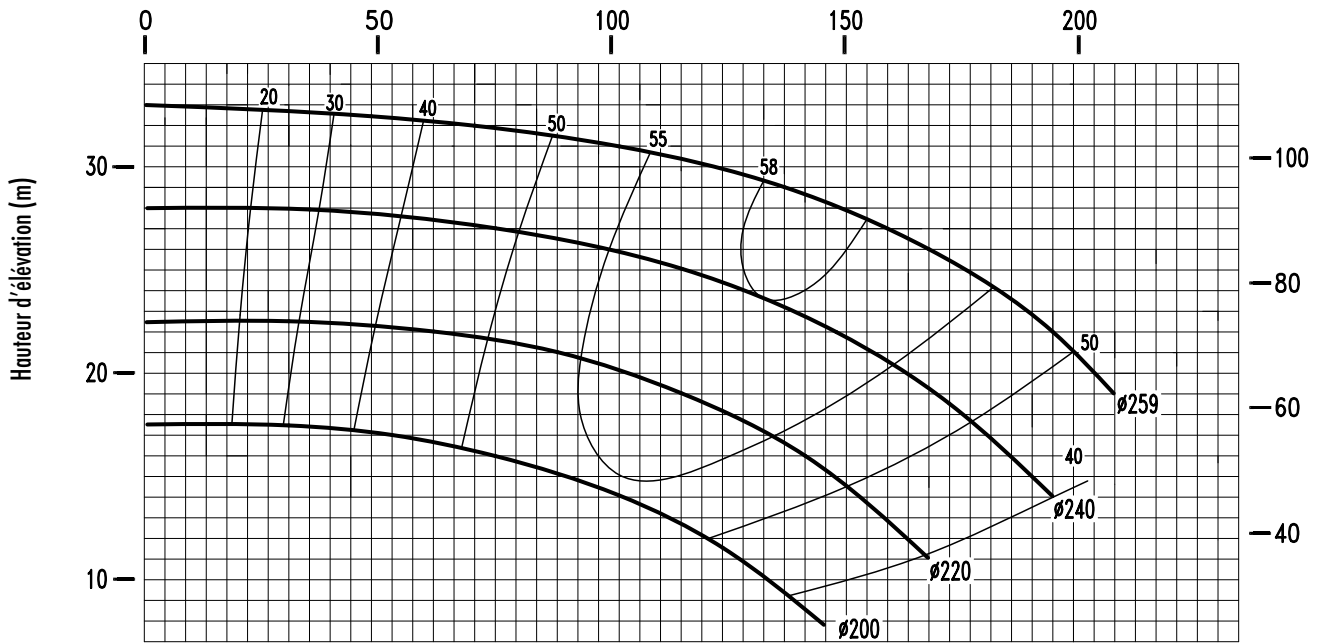

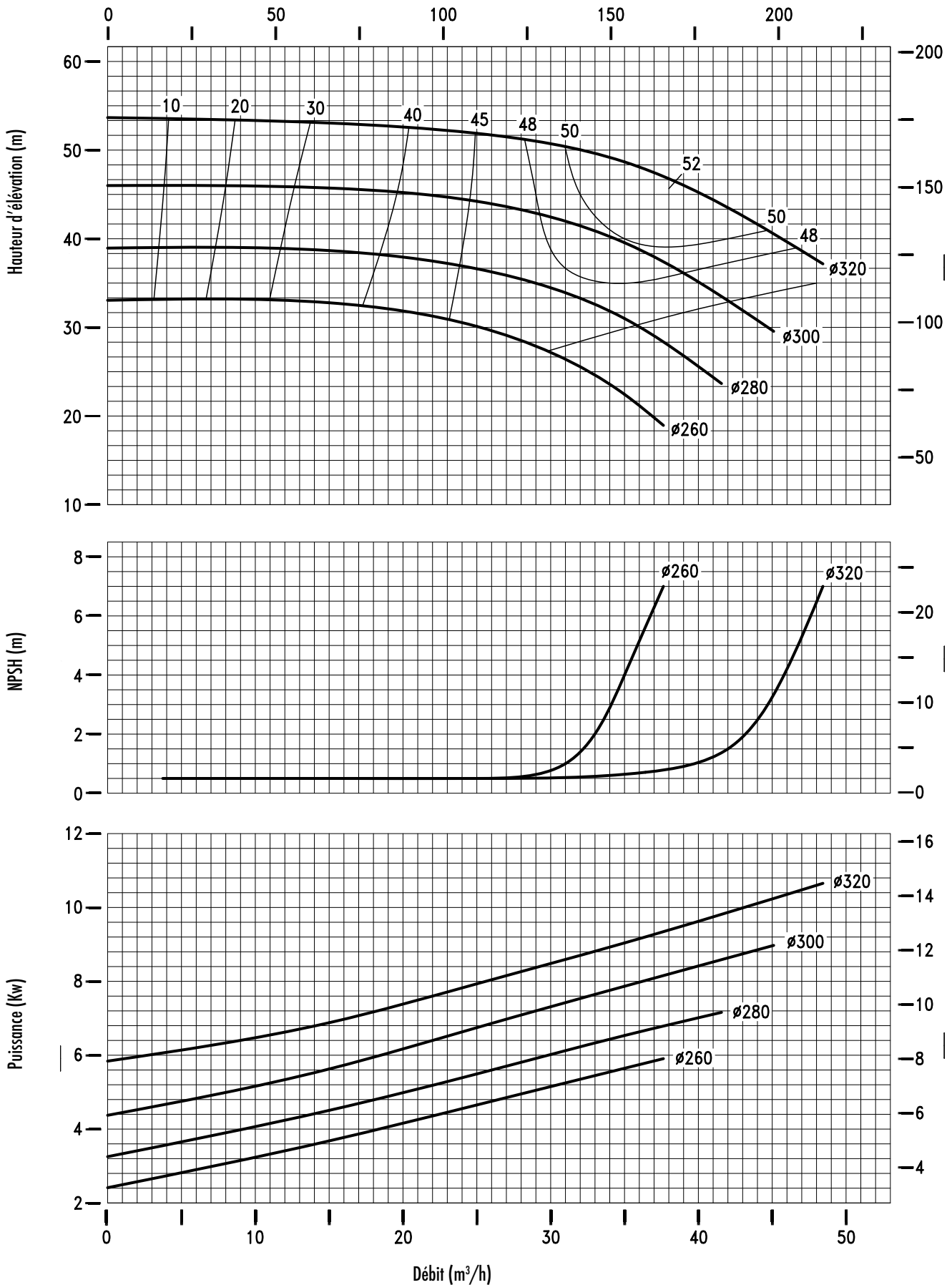



Pompes à entraînement magnétique centrifuges

Courbes Série CC Mag-M 4 x 2 x 16 - 1750 tr/mn

Projet :

Poste :

Cotation :

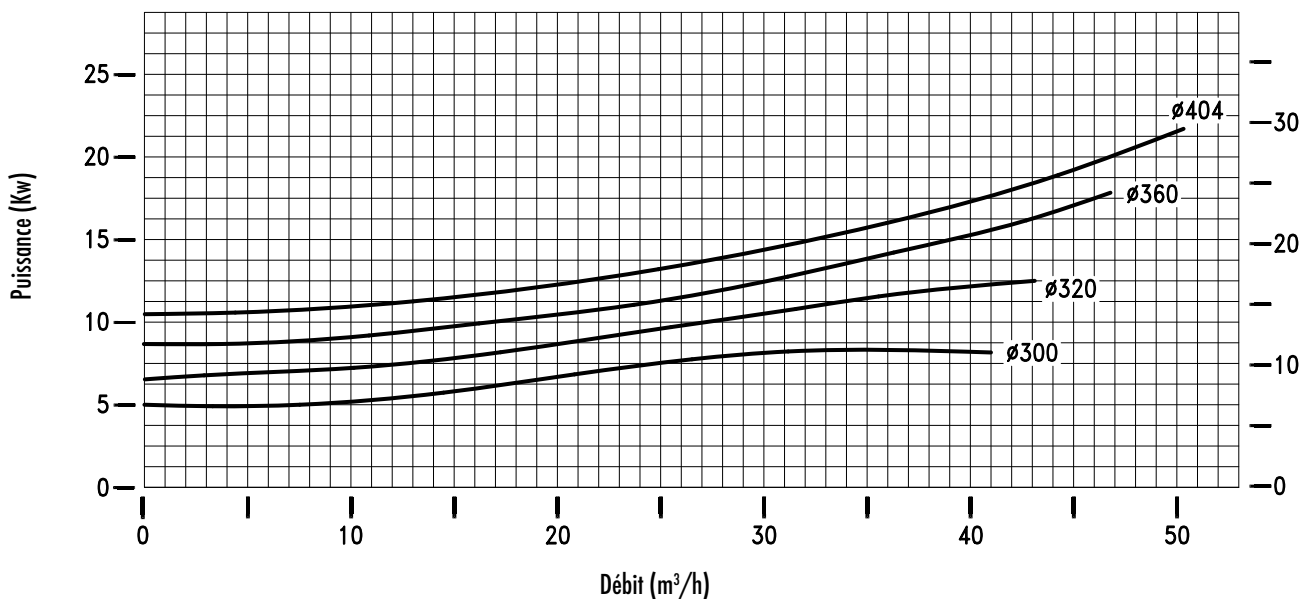
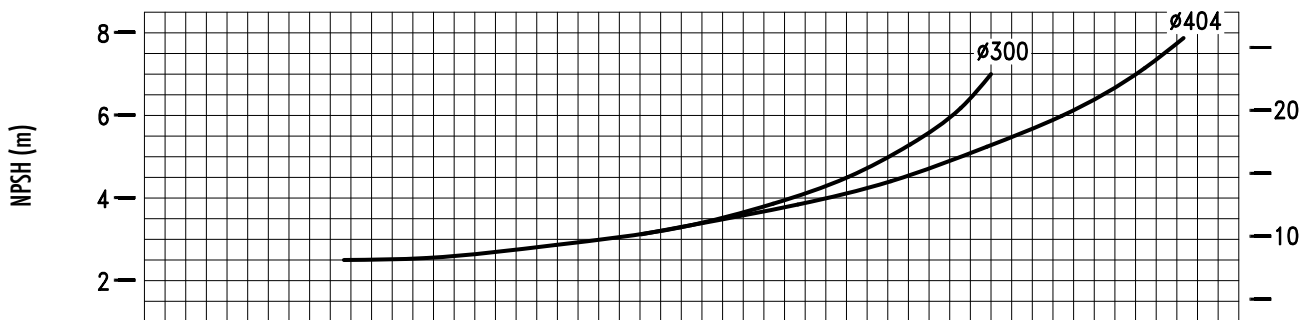
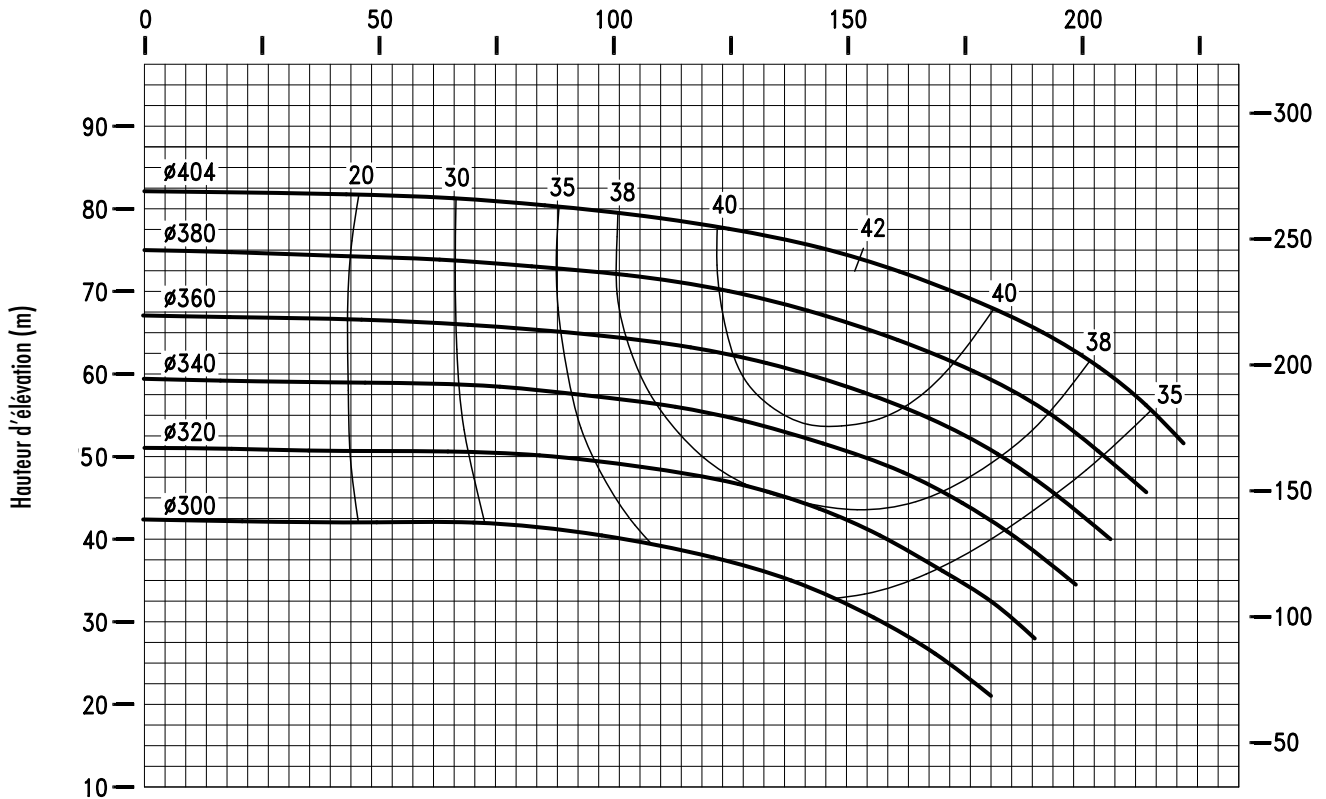

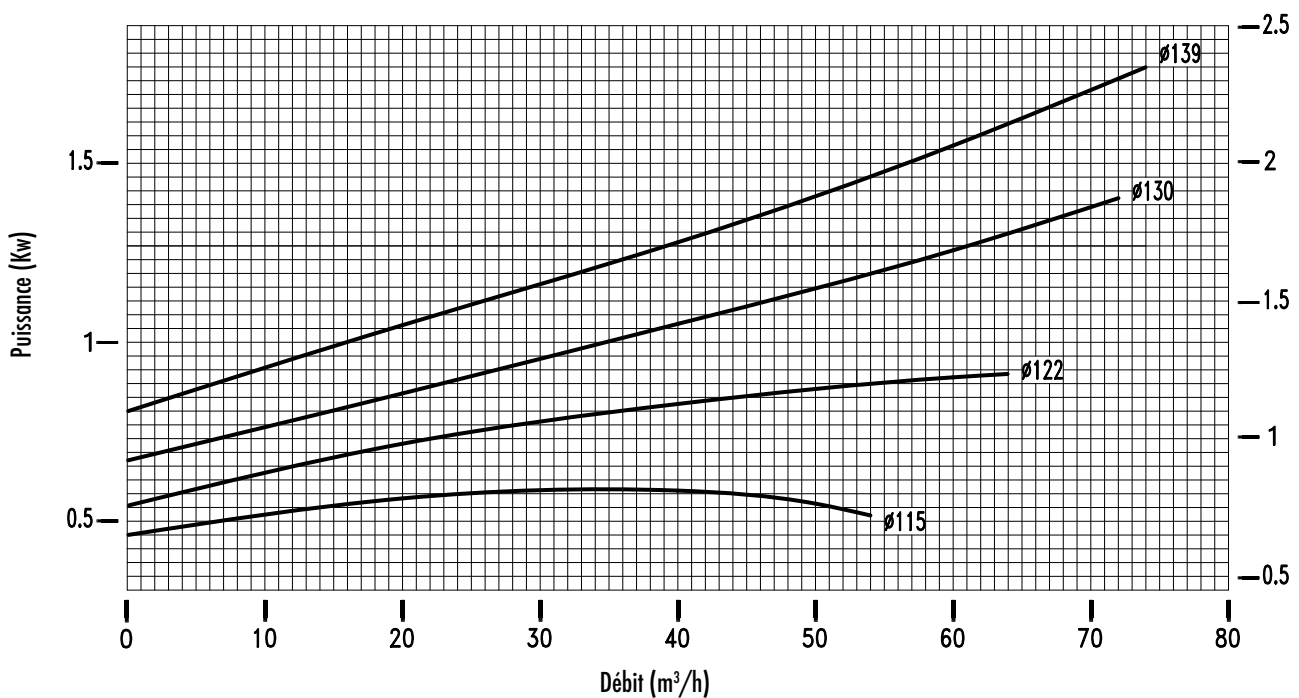
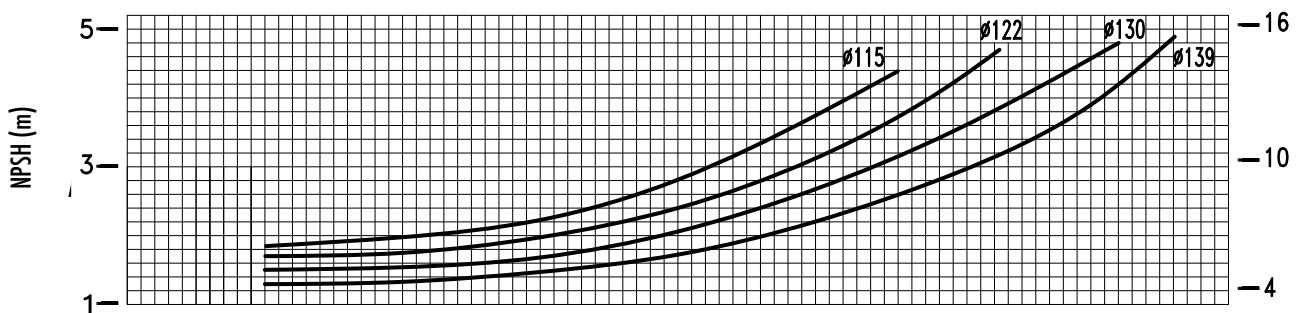
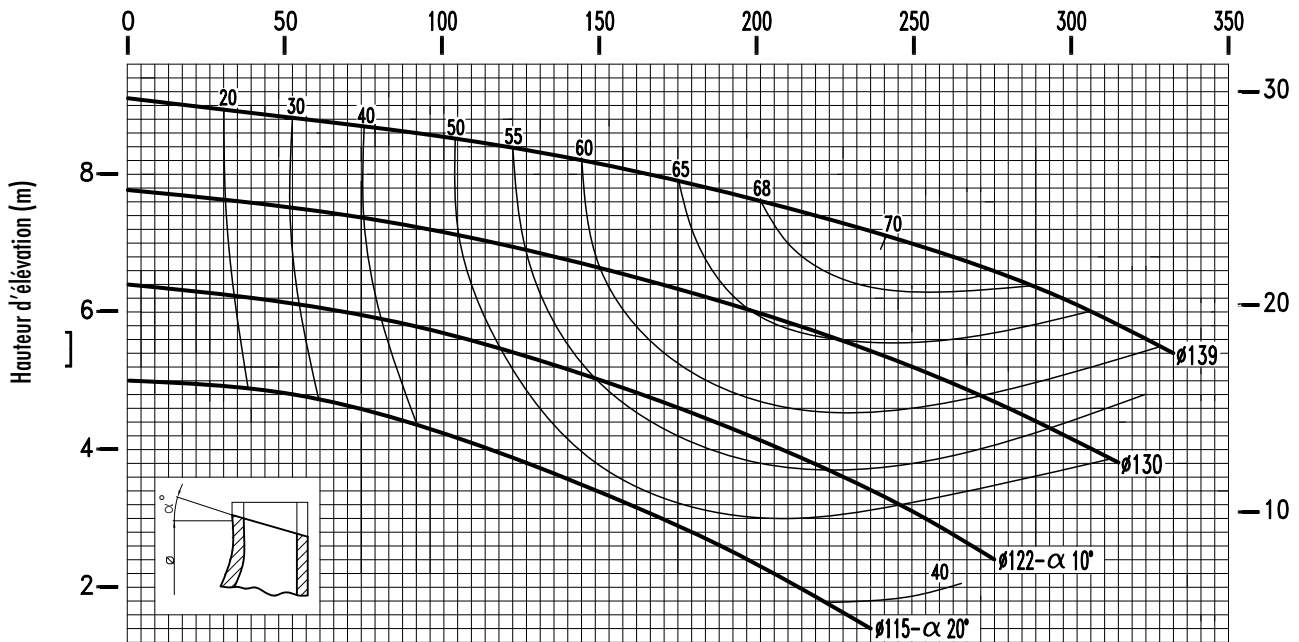

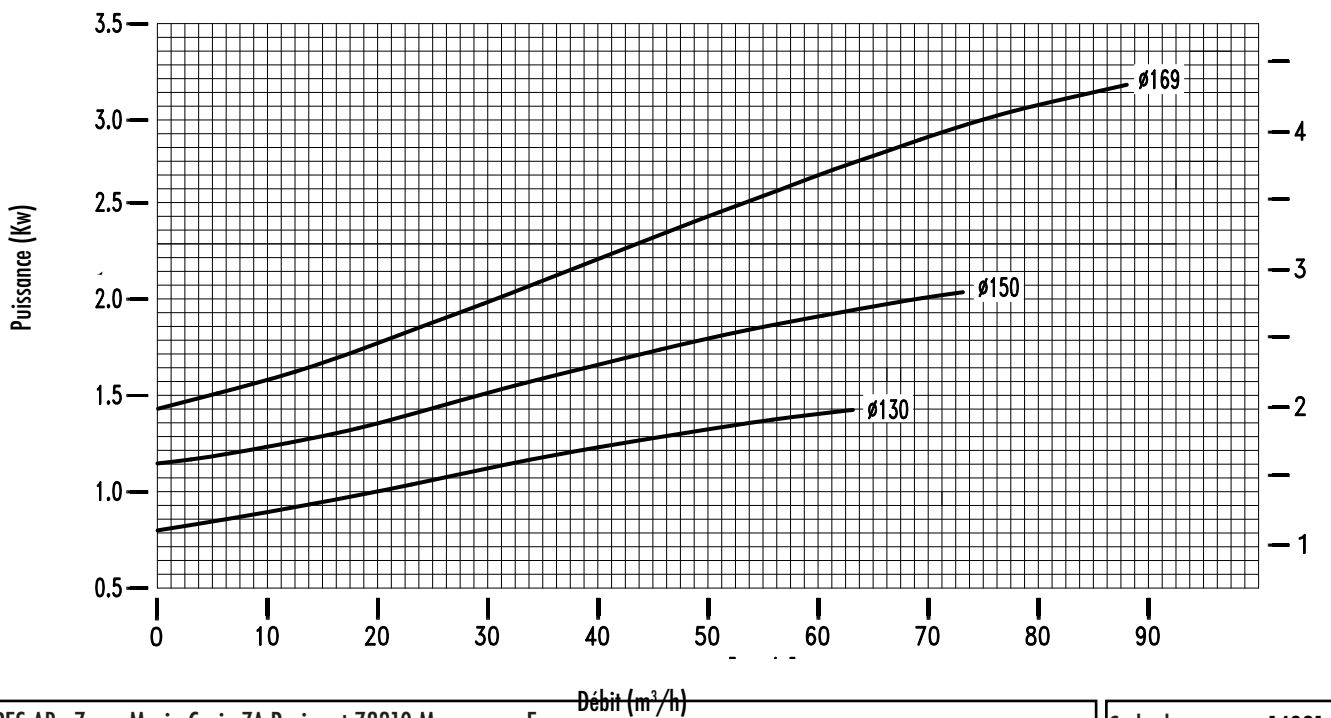
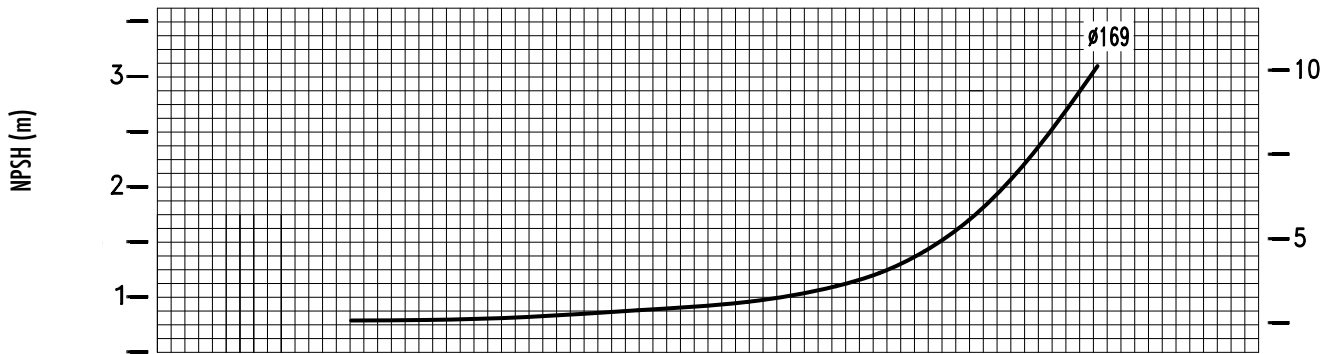
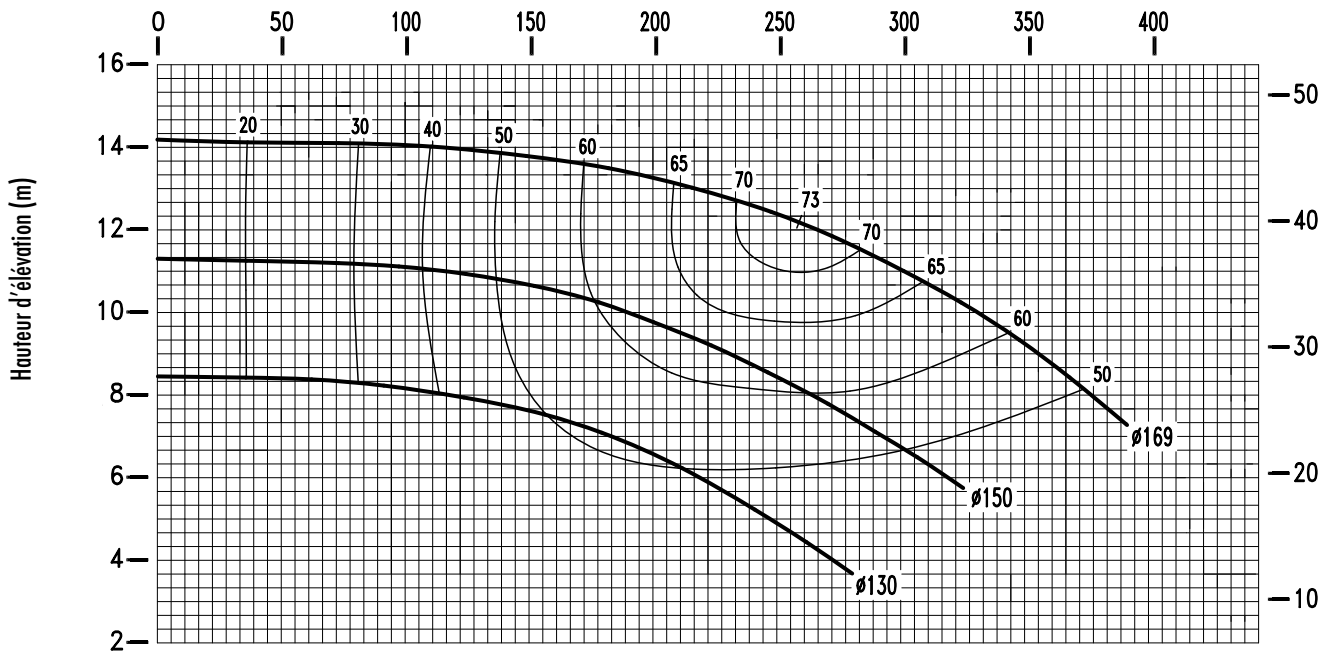

Débit (m³/h)

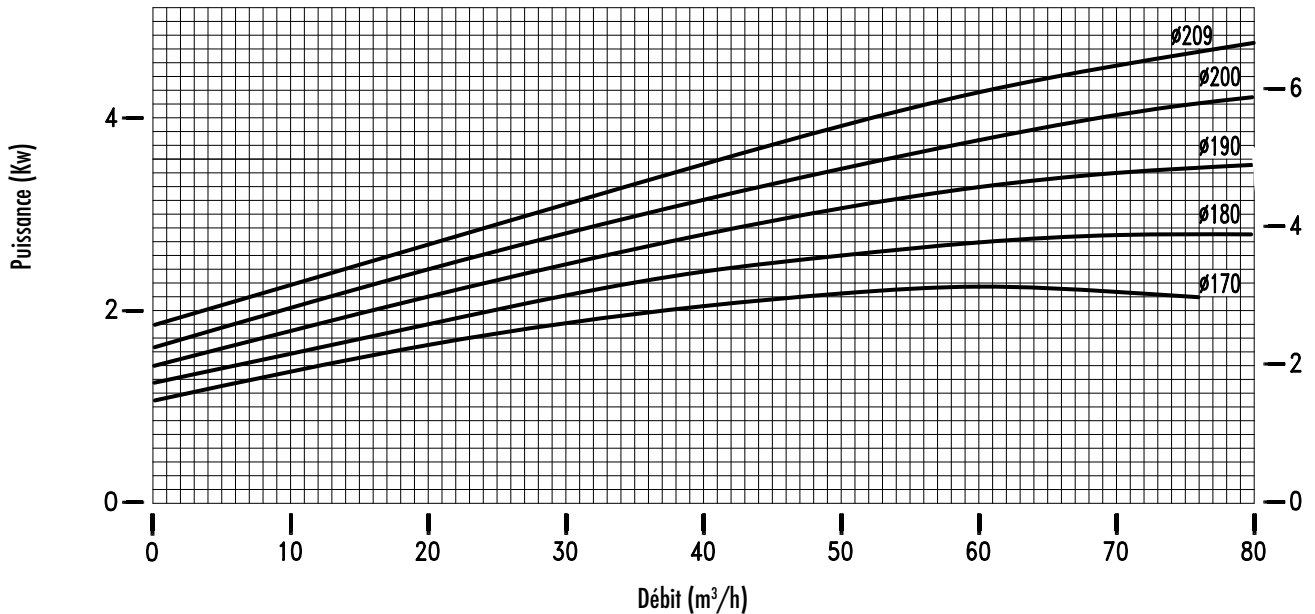
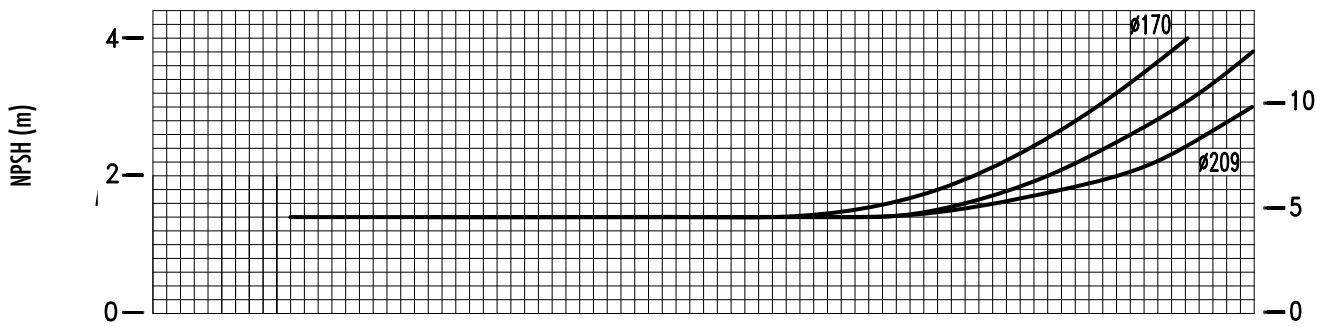
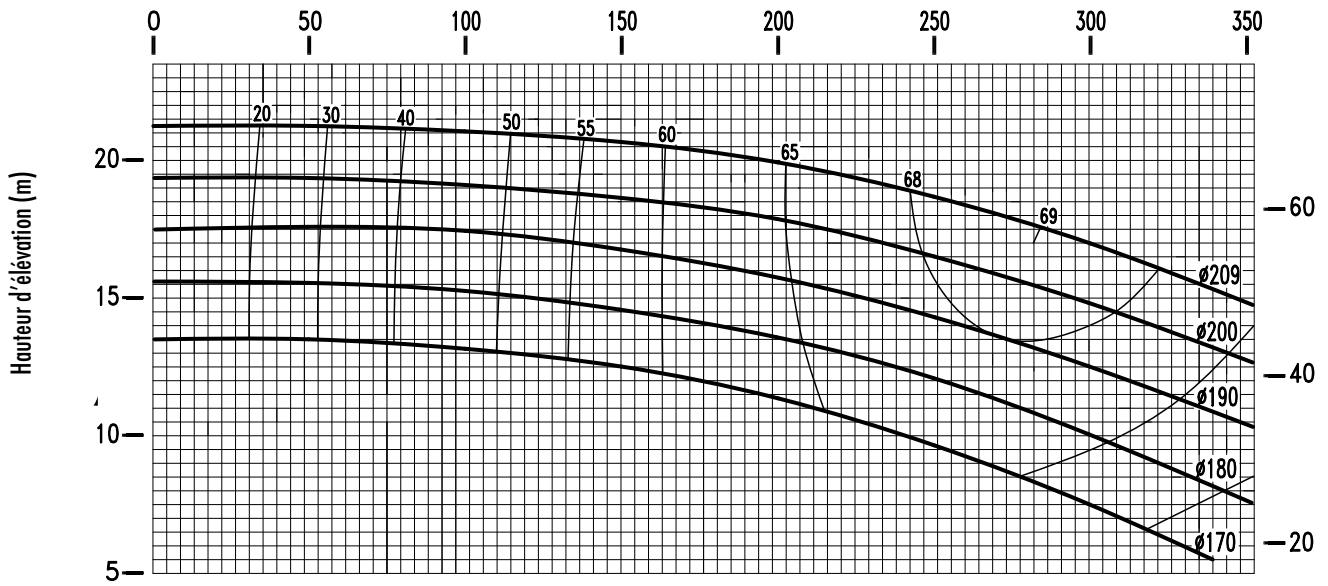

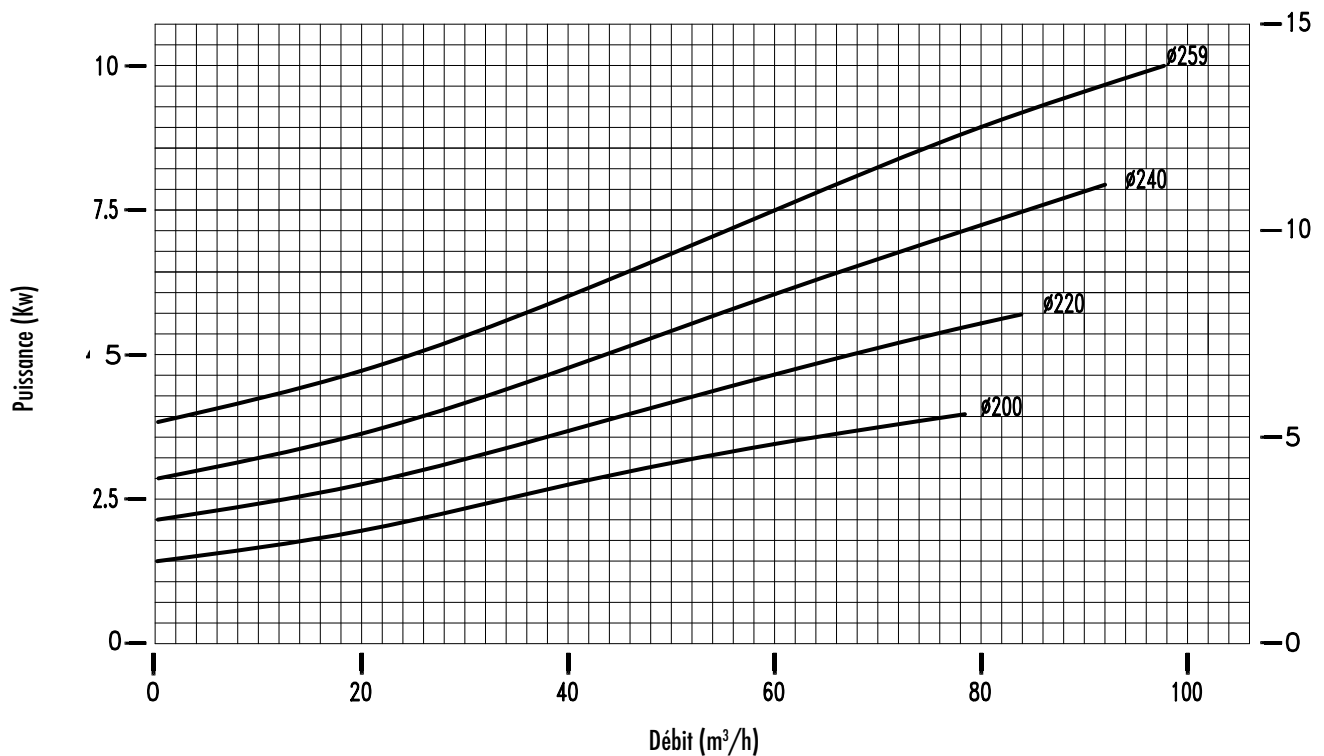
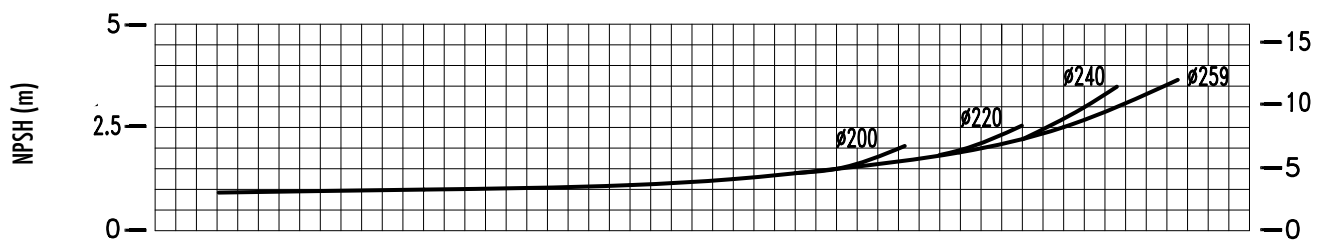
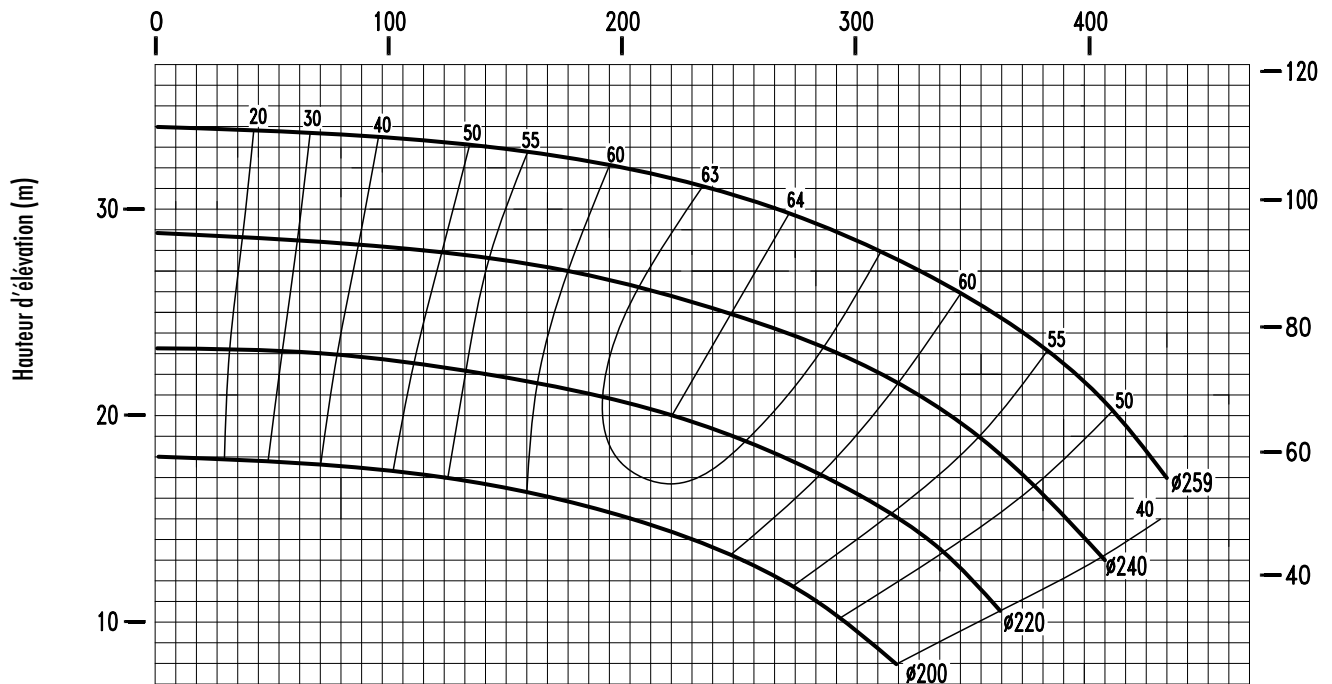

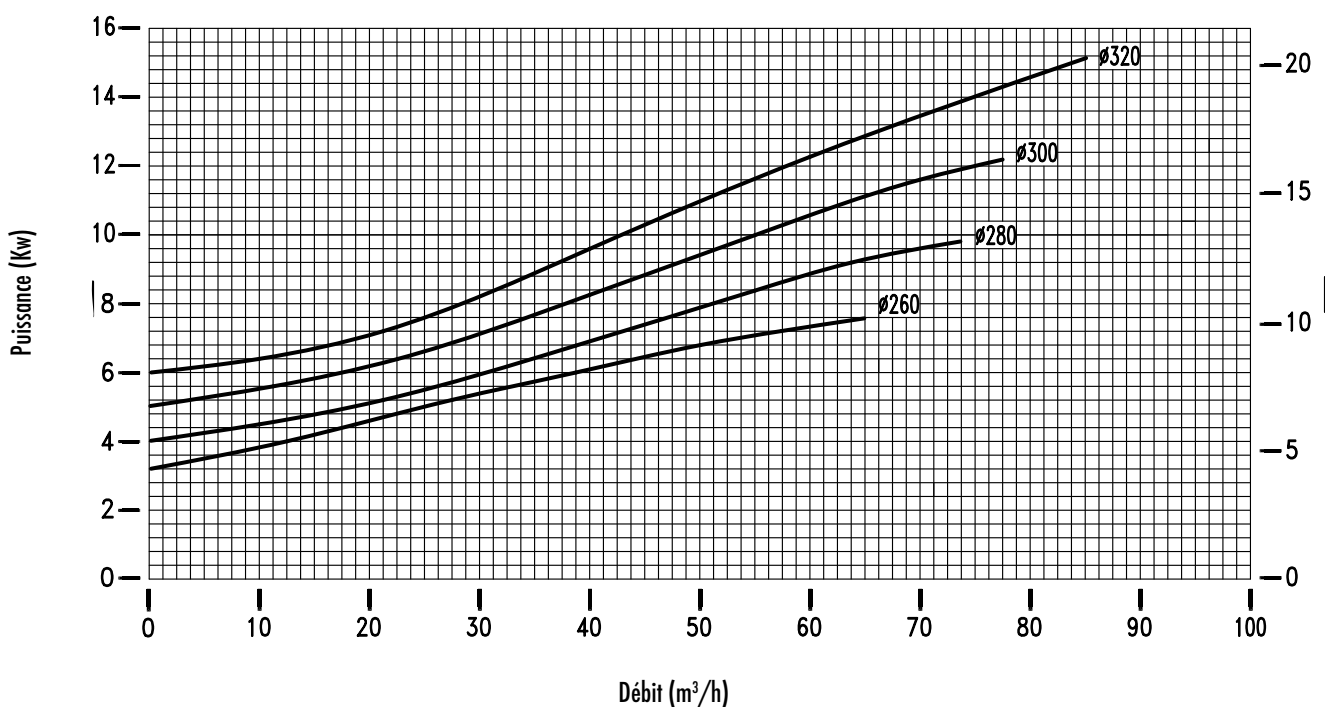
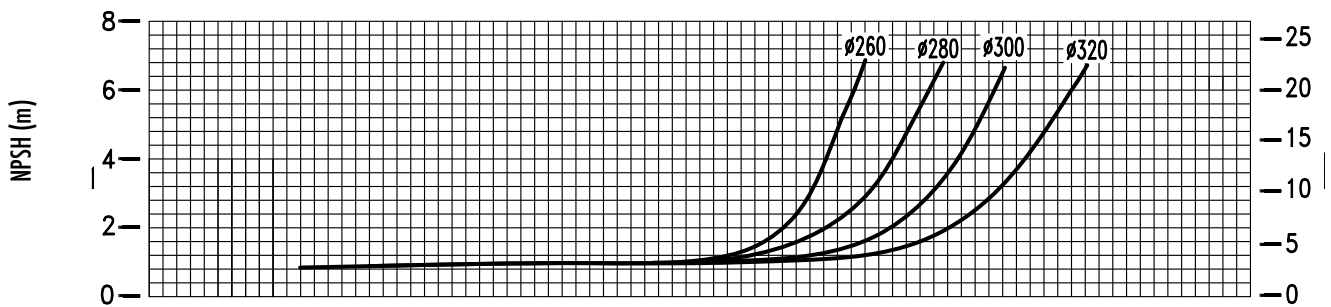
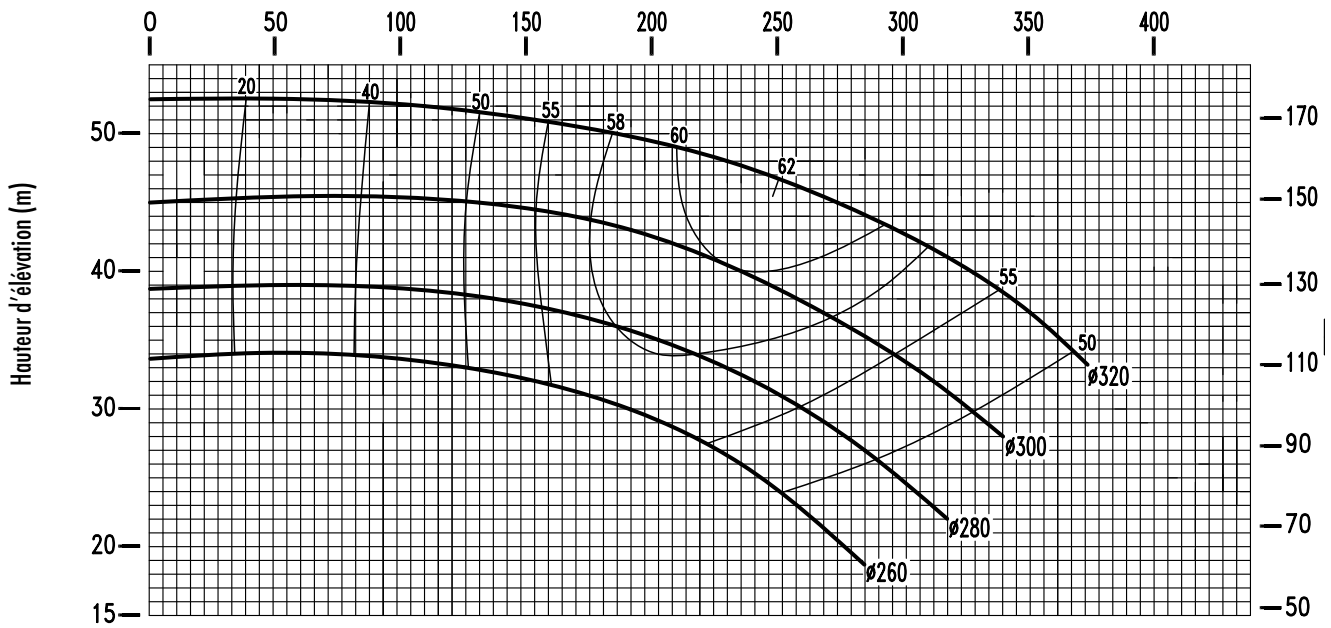

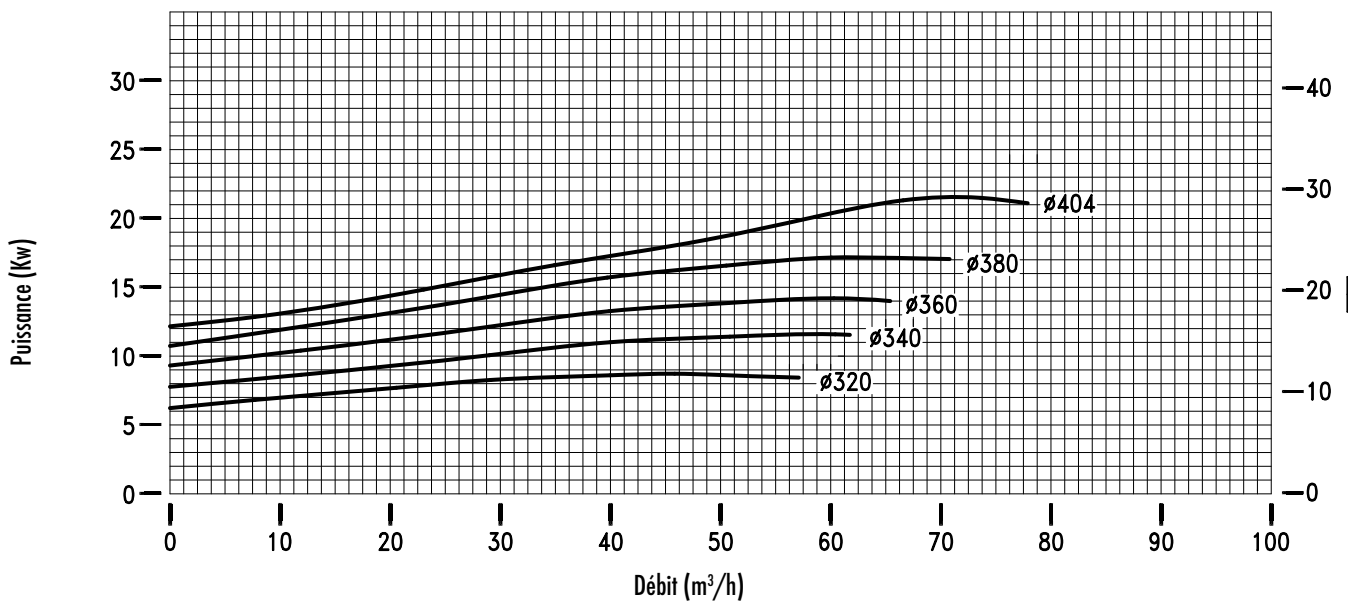
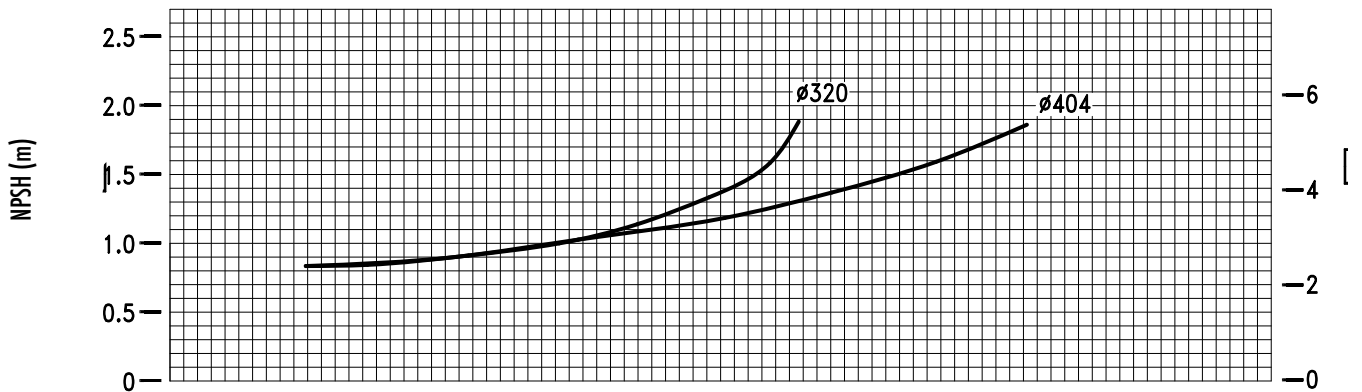
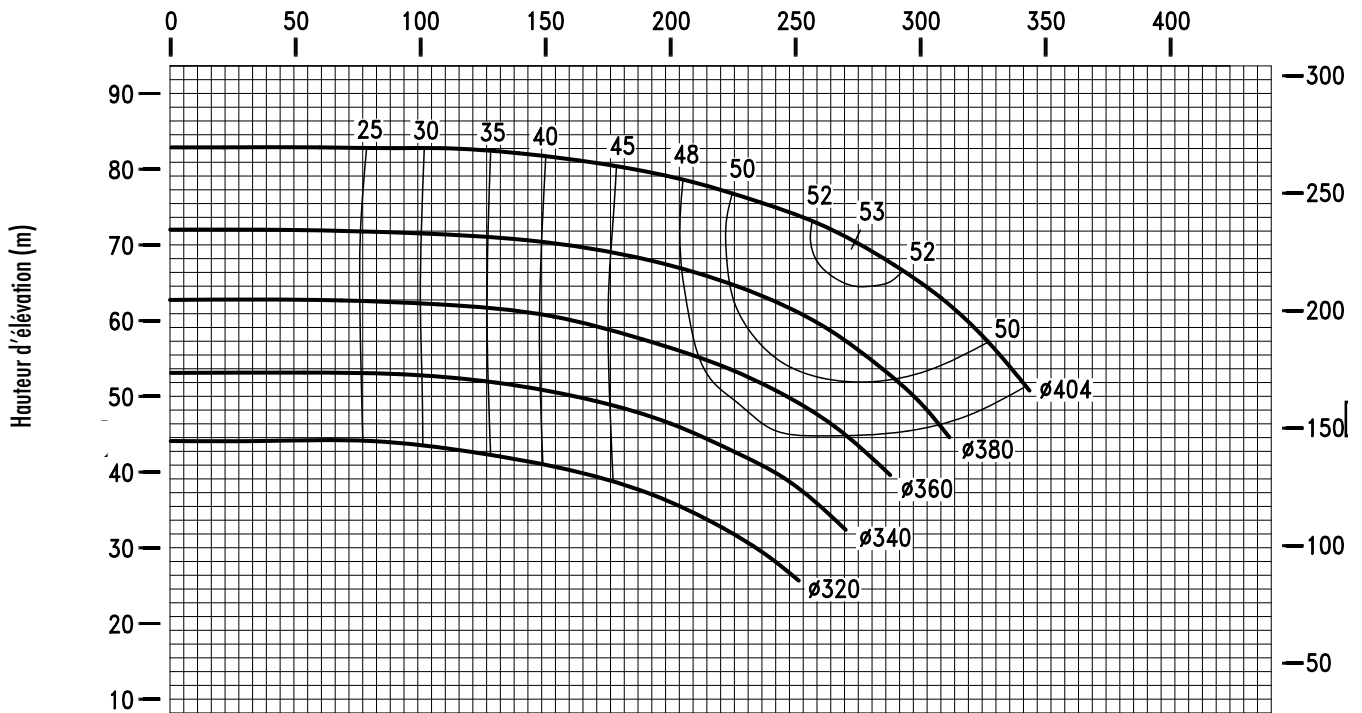

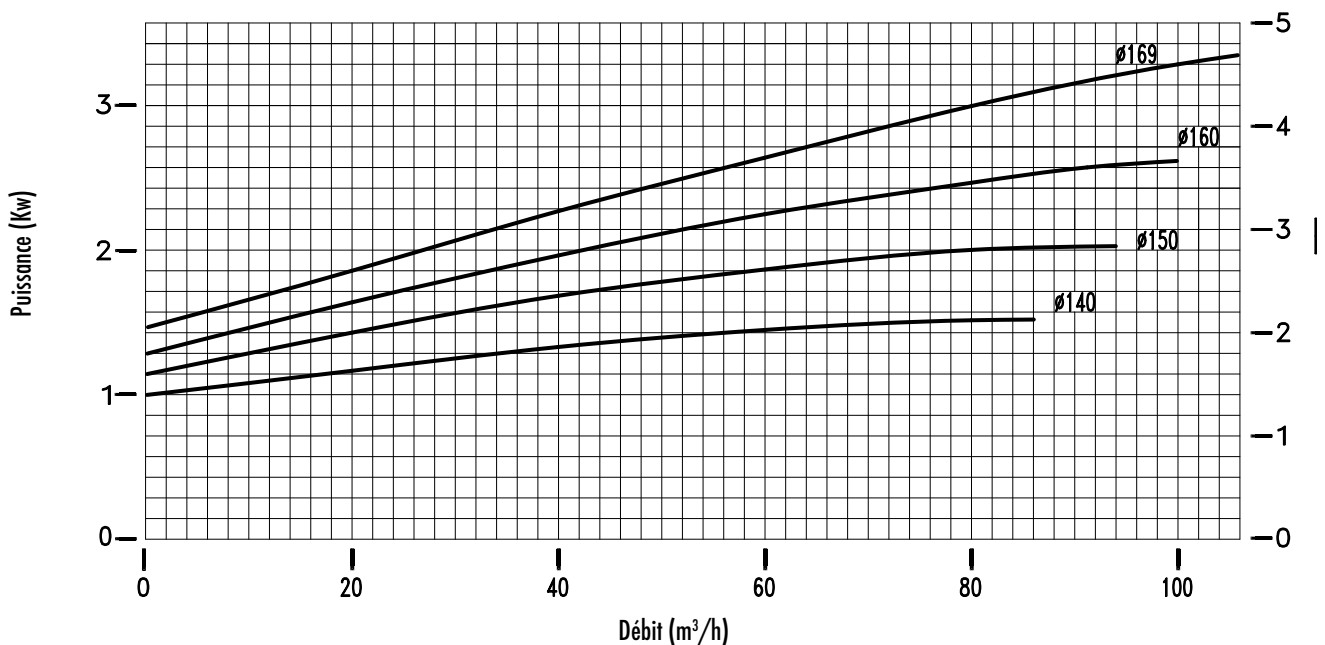
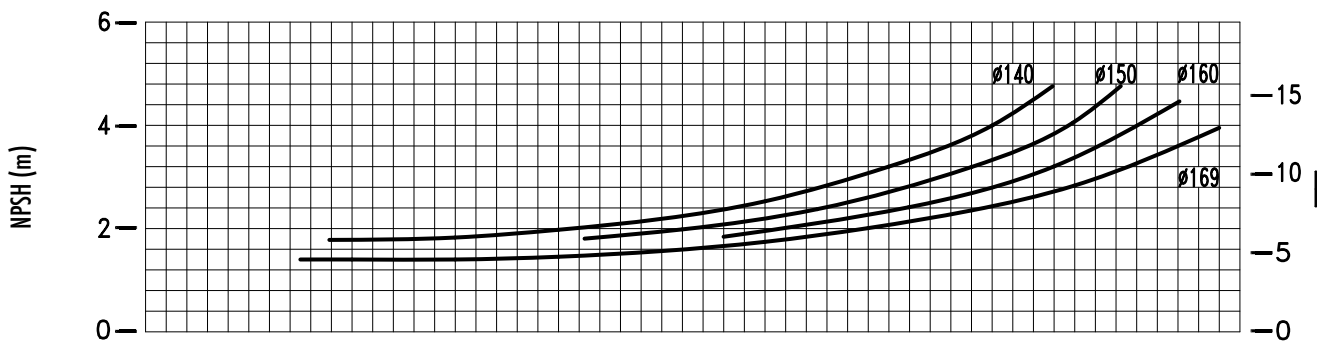
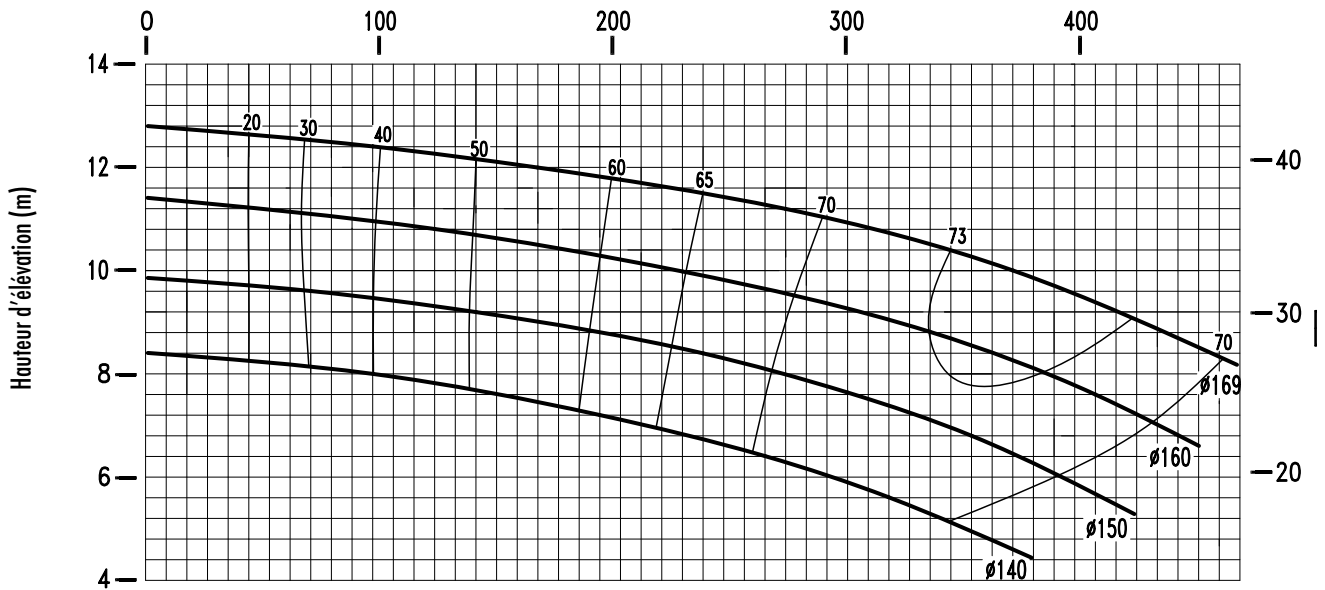

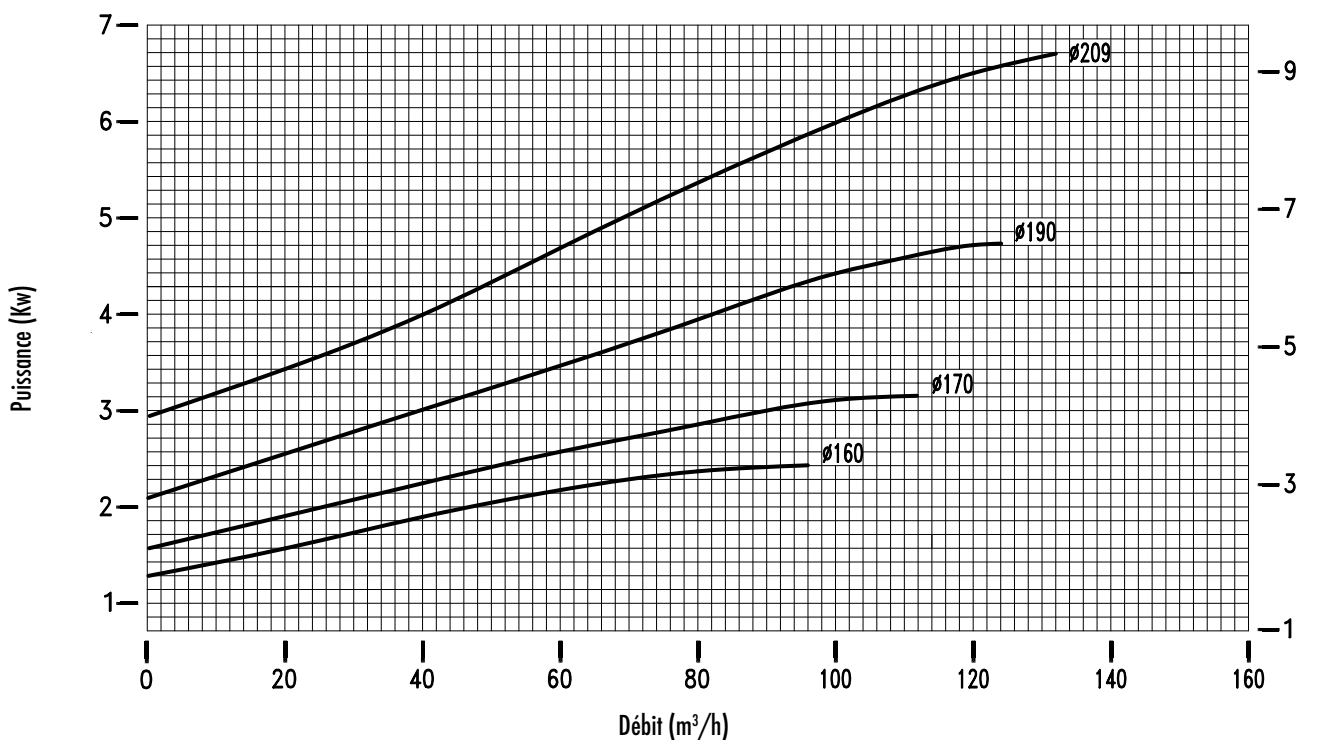
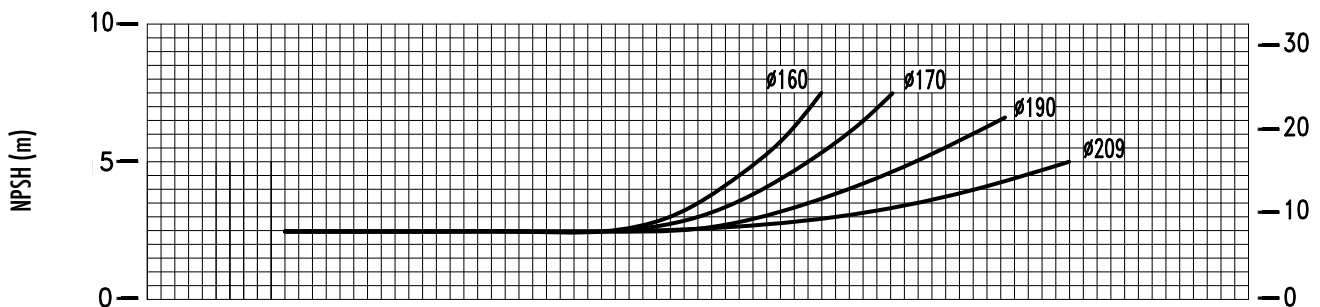
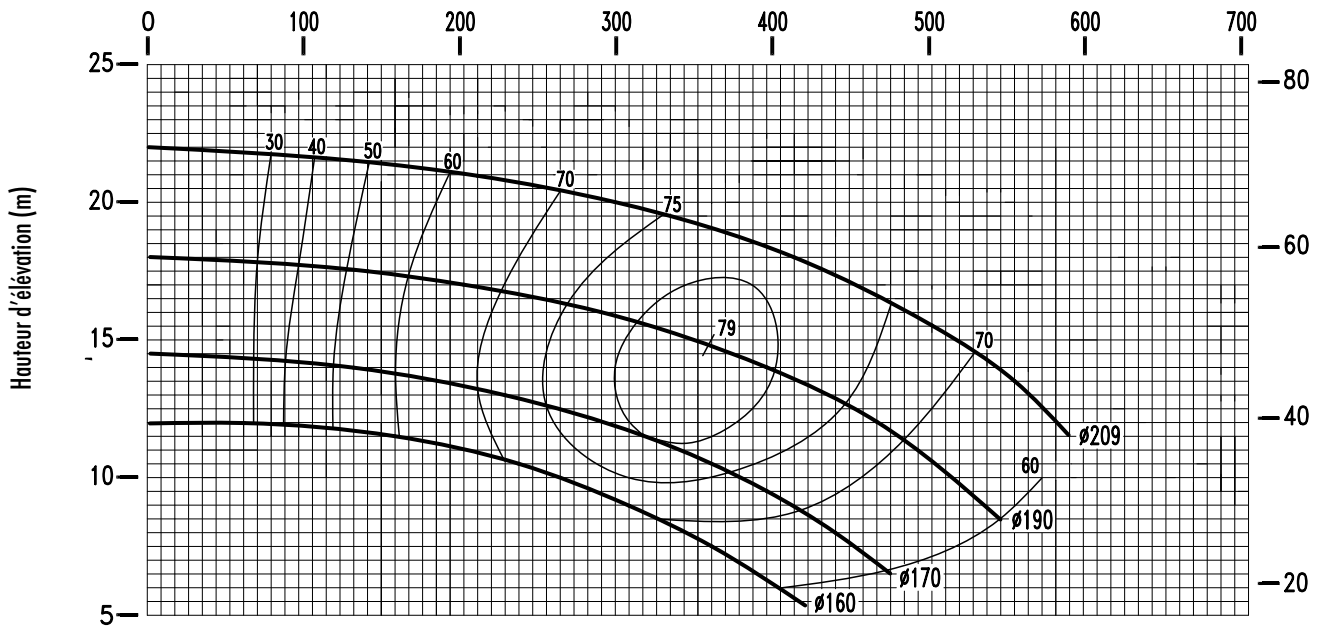

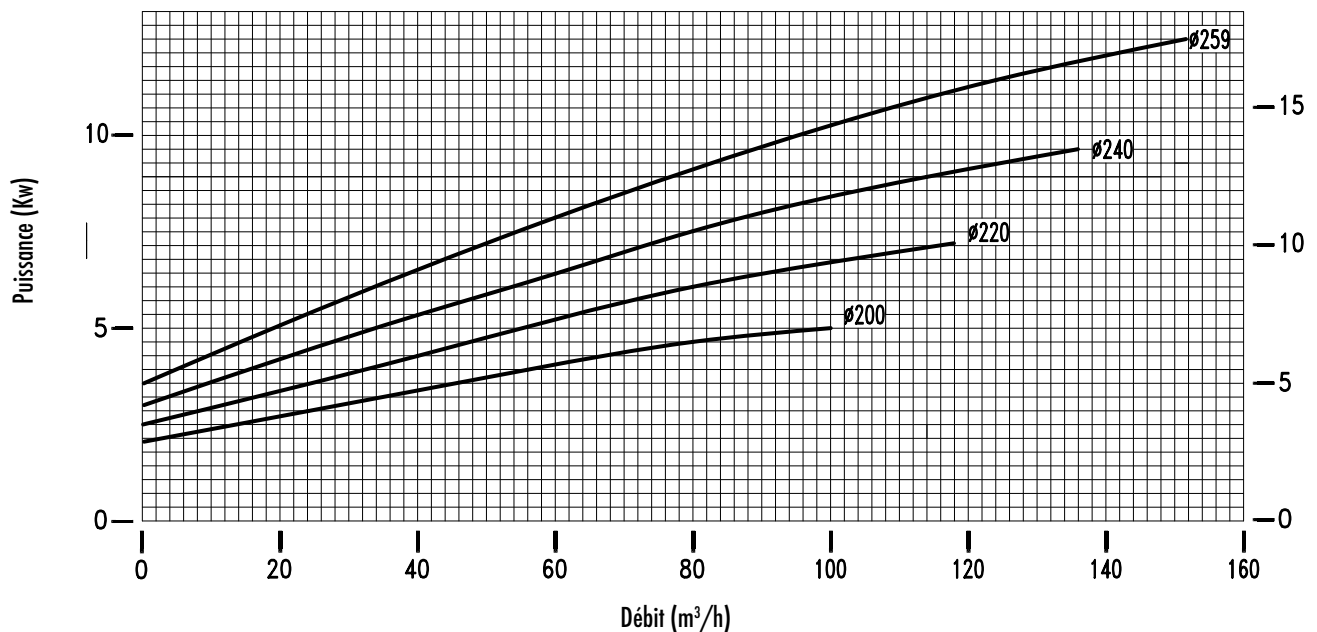
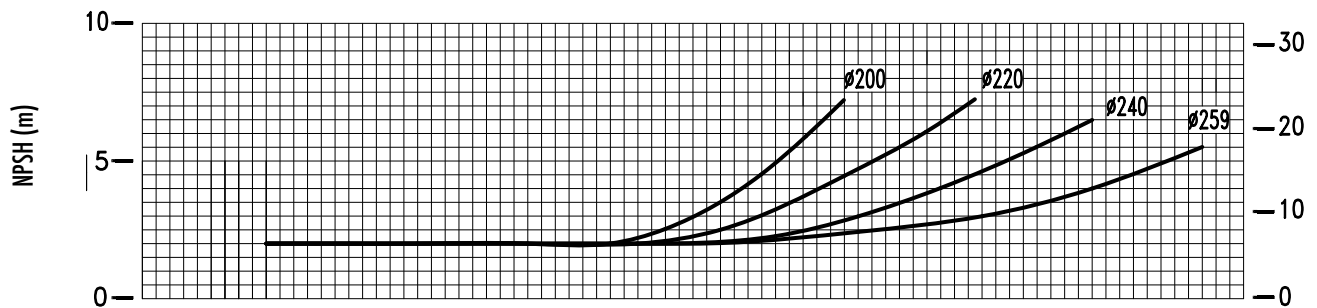
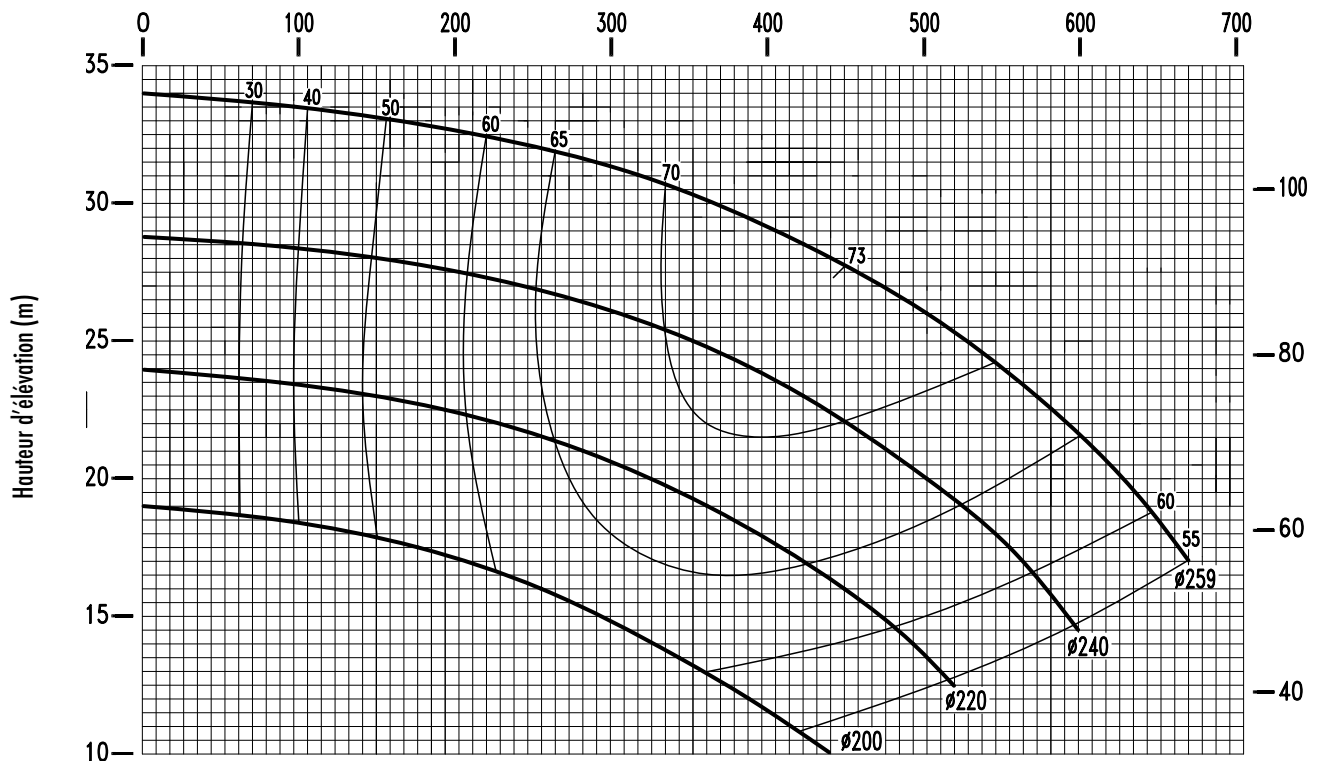



Pompes à entraînement magnétique centrifuges

Courbes Série CC Mag-M 6 x 3 x 13 - 1750 tr/mn

Projet :

Poste :

Cotation :

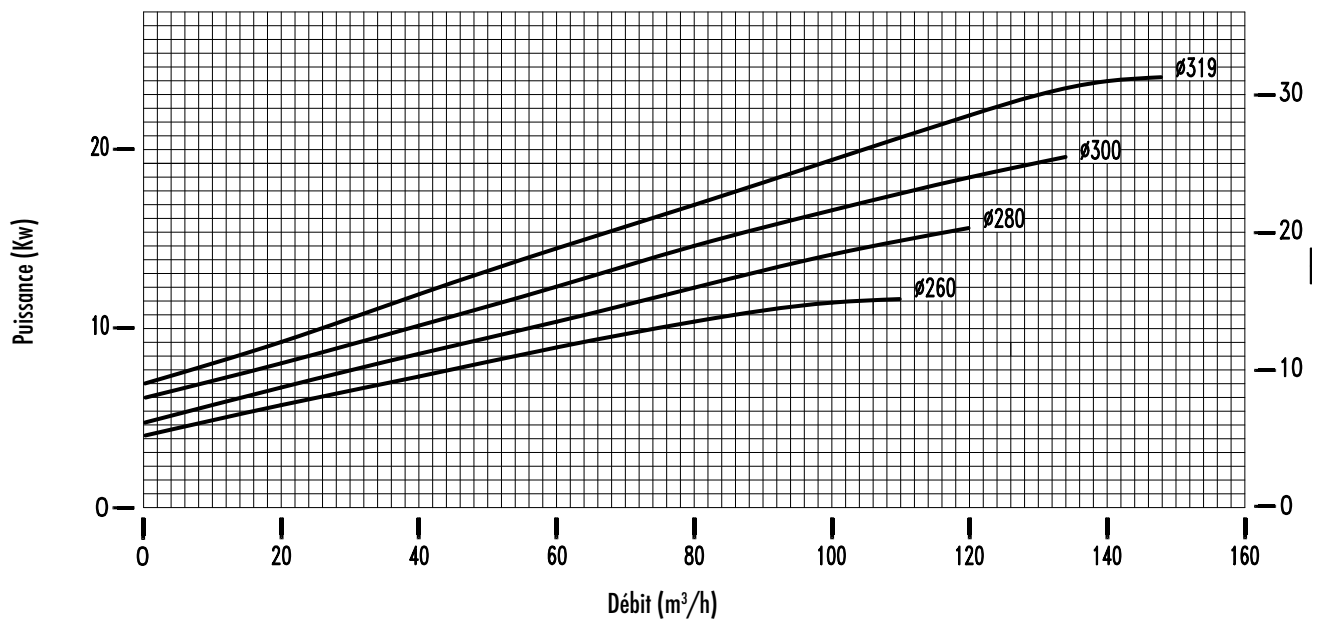
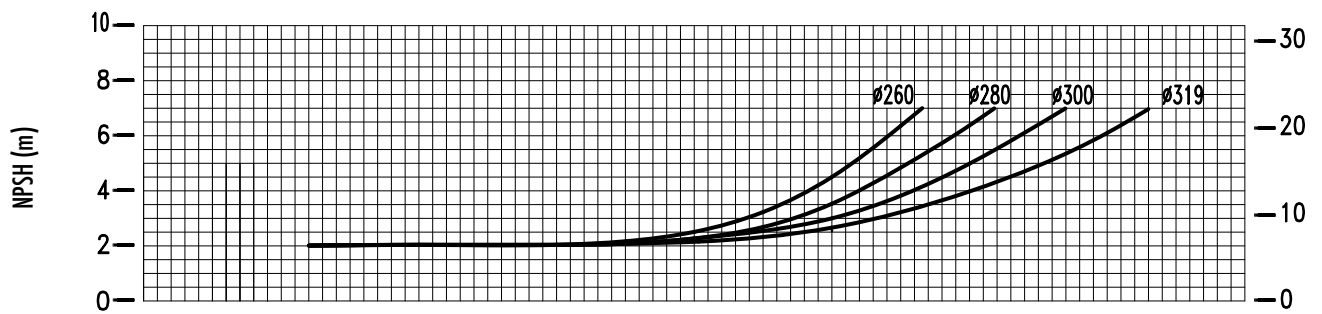
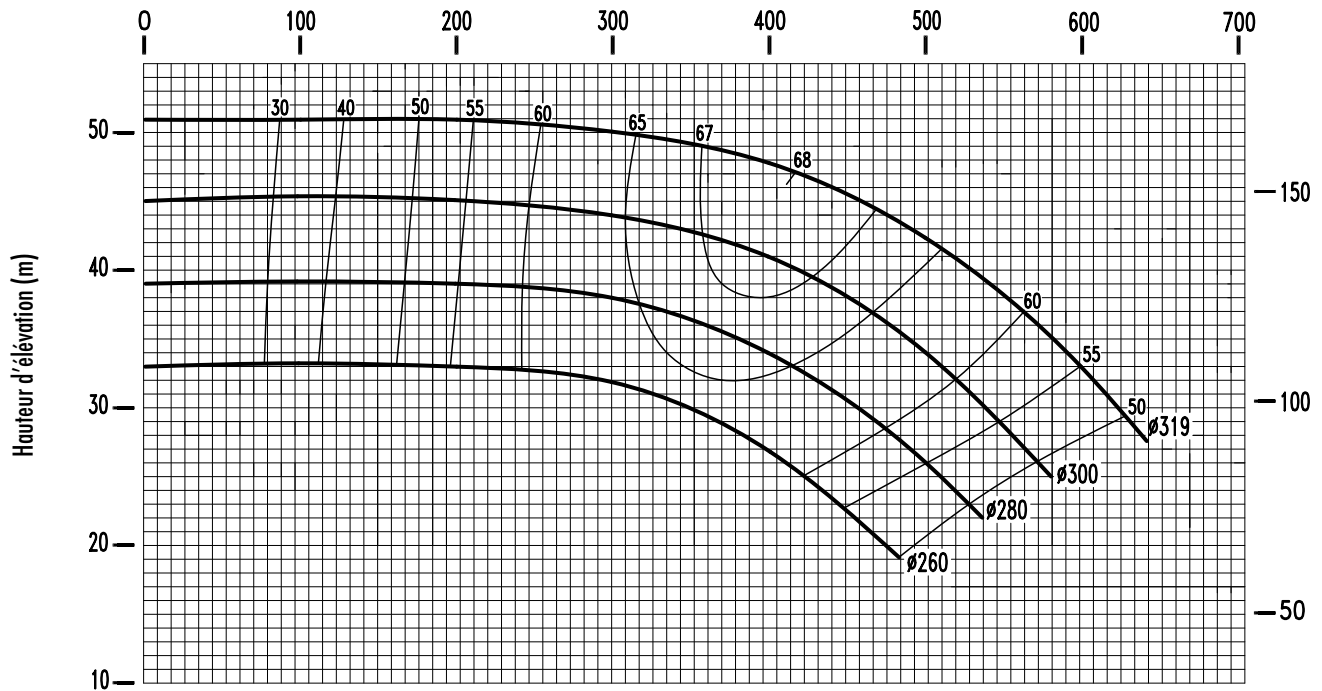

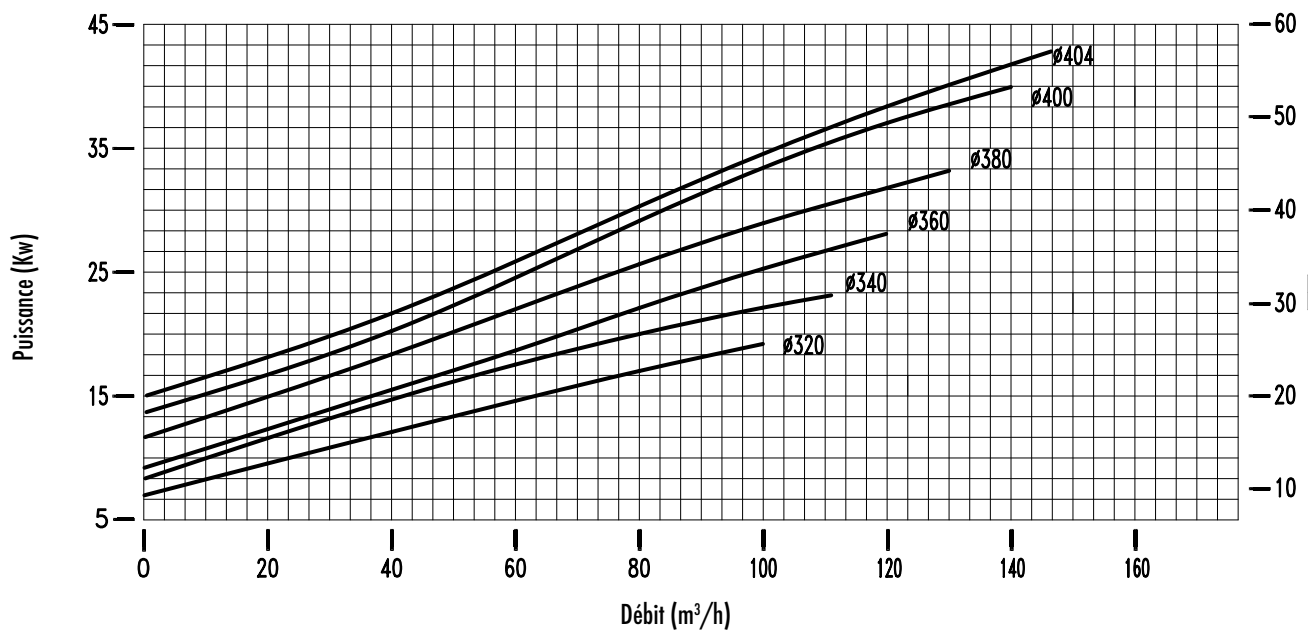
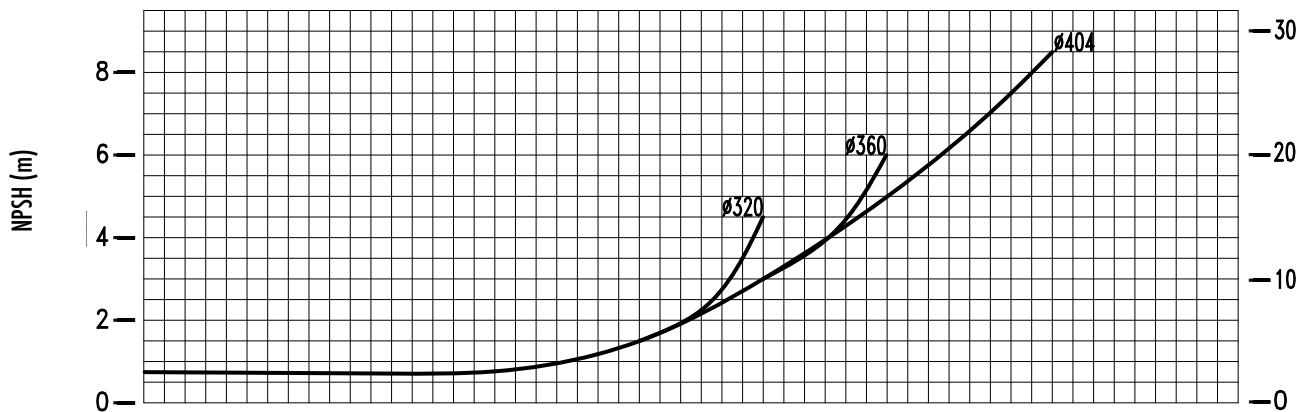
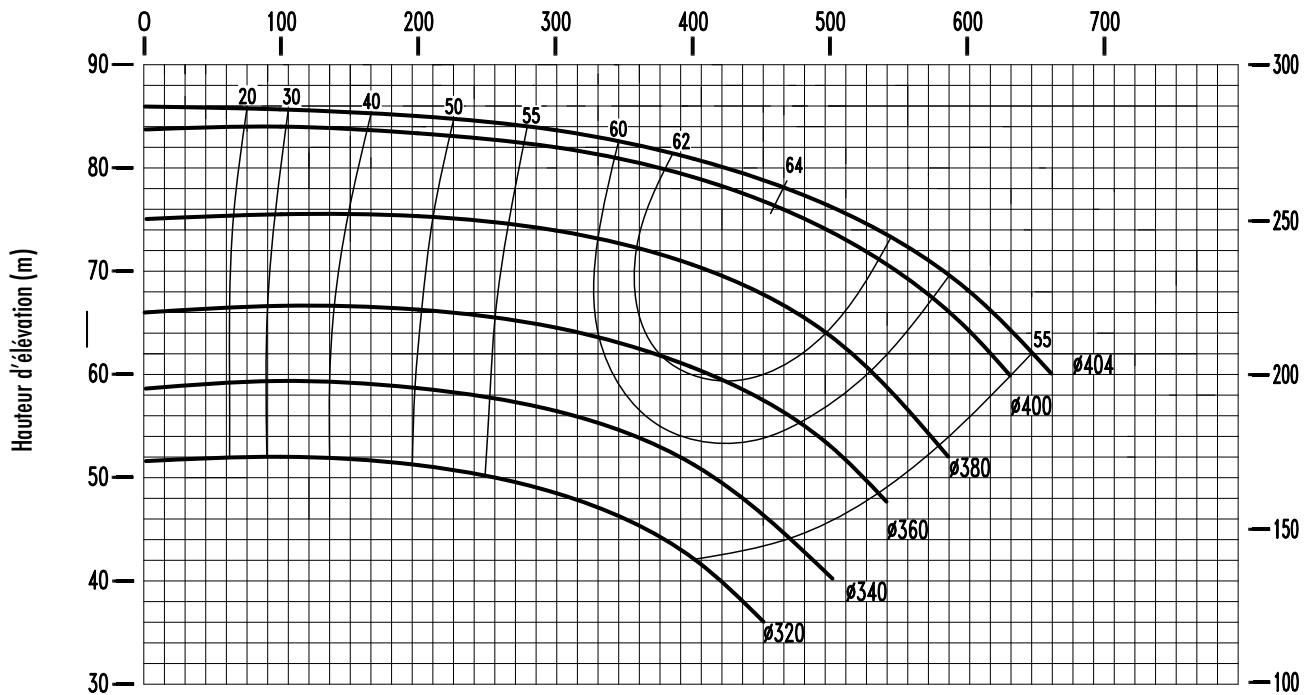

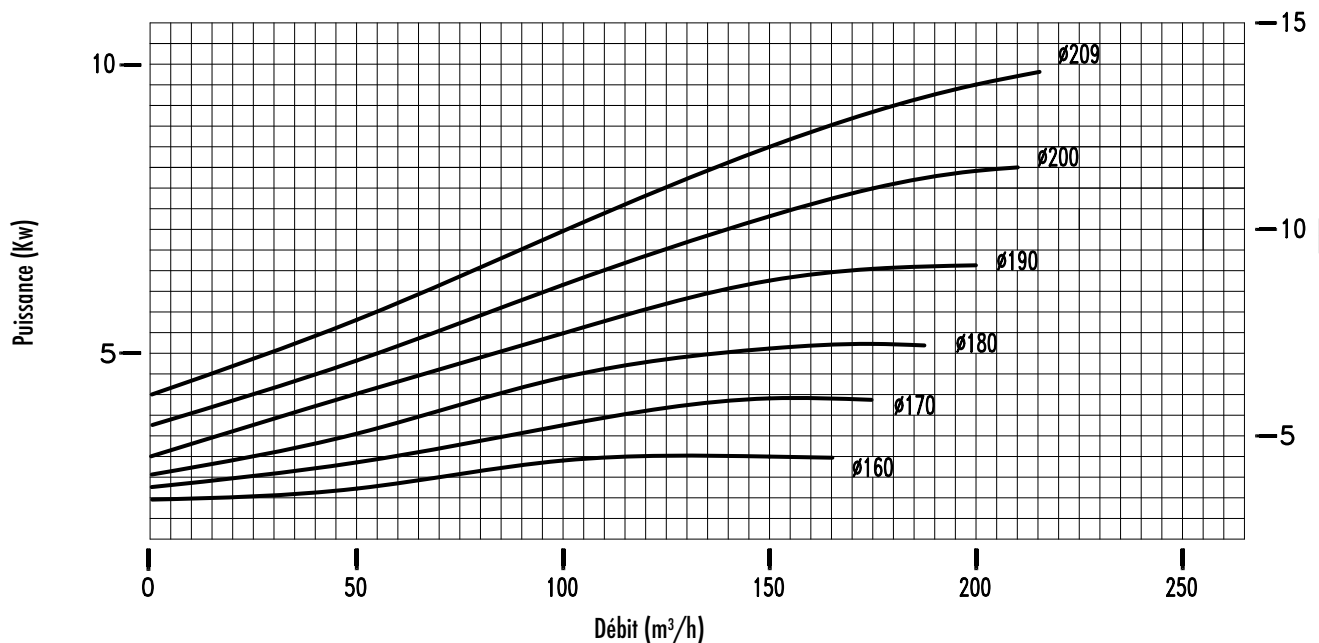
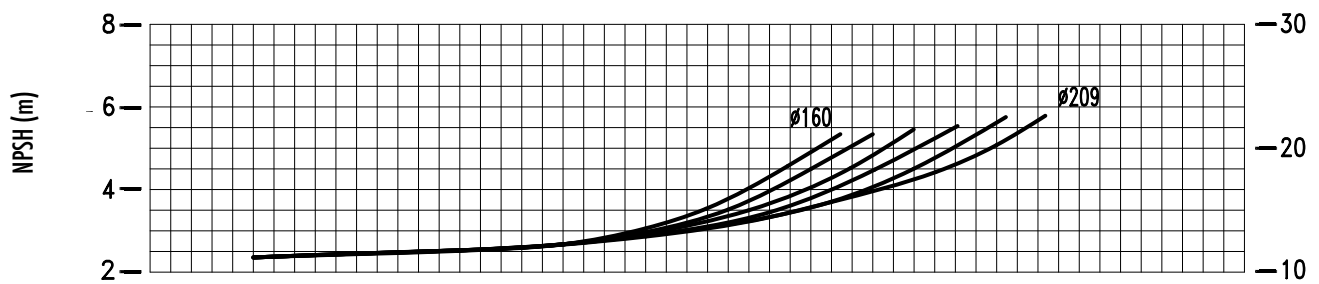
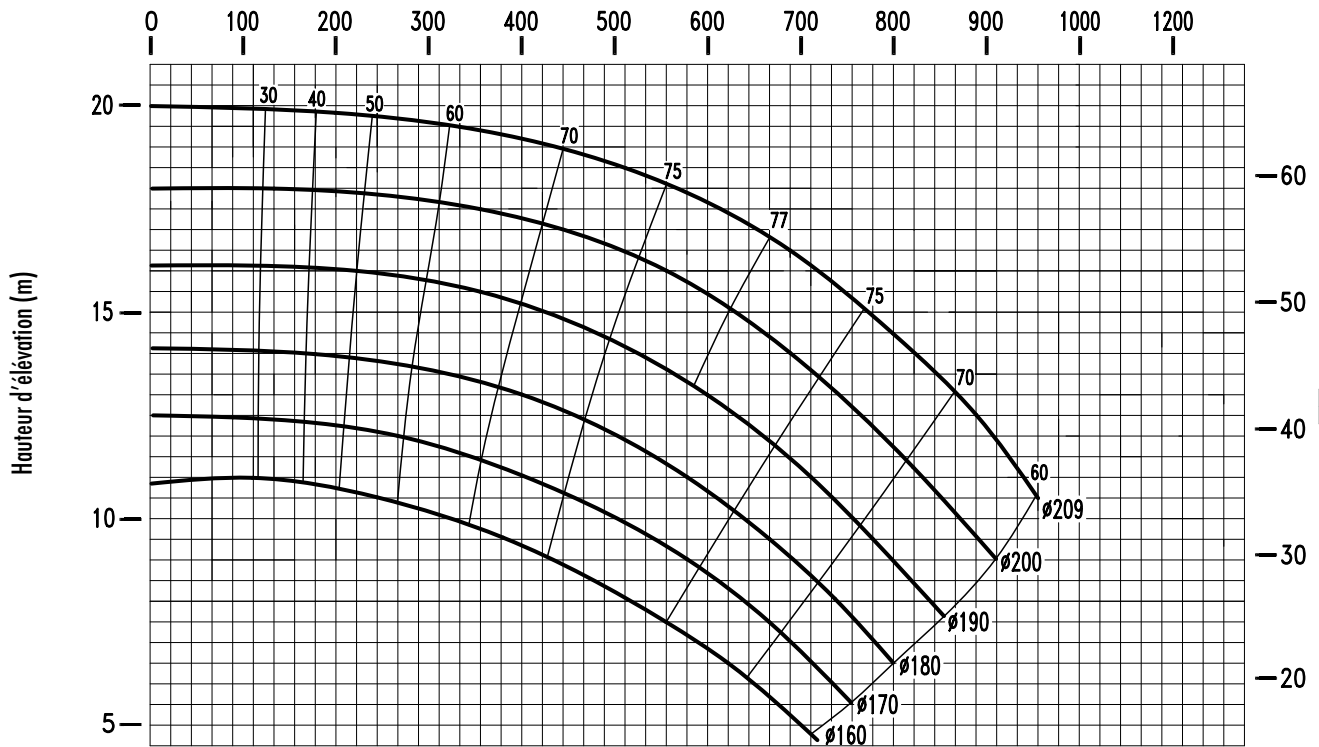



Pompes à entraînement magnétique centrifuges

Courbes Série CC Mag-M 6 x 4 x 10 - 1750 tr/mn

Projet :

Poste :

Cotation :

